

SERVICE MANUAL

GPIB DC Power Supplies Agilent Series 668xA

For instruments with Serial Numbers:

Agilent Model 6680A: US36480101 and Above *
Agilent Model 6681A: US36400101 and Above *
Agilent Model 6682A: US36440101 and Above *
Agilent Model 6683A: US36420101 and Above *
Agilent Model 6684A: US36410101 and Above *

* This manual also applies to instruments with the older serial number format described on page 7.
For instruments with higher serial numbers, a change page may be included.
For instruments with lower serial numbers, see Appendix A.



Agilent Technologies

CERTIFICATION

Agilent Technologies certifies that this product met its published specifications at time of shipment from the factory. Agilent Technologies further certifies that its calibration measurements are traceable to the United States National Bureau of Standards, to the extent allowed by the Bureau's calibration facility, and to the calibration facilities of other International Standards Organization members.

WARRANTY

This Agilent Technologies hardware product is warranted against defects in material and workmanship for a period of three years from date of delivery. Agilent Technologies software and firmware products, which are designated by Agilent Technologies for use with a hardware product and when properly installed on that hardware product, are warranted not to fail to execute their programming instructions due to defects in material and workmanship for a period of 90 days from date of delivery. During the warranty period Agilent Technologies will, at its option, either repair or replace products which prove to be defective. Agilent Technologies does not warrant that the operation of the software, firmware, or hardware shall be uninterrupted or error free.

For warranty service, with the exception of warranty options, this product must be returned to a service facility designated by Agilent Technologies. Customer shall prepay shipping charges by (and shall pay all duty and taxes) for products returned to Agilent Technologies for warranty service. Except for products returned to Customer from another country, Agilent Technologies shall pay for return of products to Customer.

Warranty services outside the country of initial purchase are included in Agilent Technologies product price, only if Customer pays Agilent Technologies international prices (defined as destination local currency price, or U.S. or Geneva Export price).

If Agilent Technologies is unable, within a reasonable time to repair or replace any product to condition as warranted, the Customer shall be entitled to a refund of the purchase price upon return of the product to Agilent Technologies.

LIMITATION OF WARRANTY

The foregoing warranty shall not apply to defects resulting from improper or inadequate maintenance by the Customer, Customer-supplied software or interfacing, unauthorized modification or misuse, operation outside of the environmental specifications for the product, or improper site preparation and maintenance. **NO OTHER WARRANTY IS EXPRESSED OR IMPLIED. AGILENT TECHNOLOGIES SPECIFICALLY DISCLAIMS THE IMPLIED WARRANTIES OF MERCHANTABILITY AND FITNESS FOR A PARTICULAR PURPOSE.**

EXCLUSIVE REMEDIES

THE REMEDIES PROVIDED HEREIN ARE THE CUSTOMER'S SOLE AND EXCLUSIVE REMEDIES. AGILENT SHALL NOT BE LIABLE FOR ANY DIRECT, INDIRECT, SPECIAL, INCIDENTAL, OR CONSEQUENTIAL DAMAGES, WHETHER BASED ON CONTRACT, TORT, OR ANY OTHER LEGAL THEORY.

ASSISTANCE

The above statements apply only to the standard product warranty. Warranty options, extended support contracts, product maintenance agreements and customer assistance agreements are also available. Contact your nearest Agilent Technologies Sales and Service office for further information on Agilent Technologies' full line of Support Programs.

SAFETY CONSIDERATIONS

GENERAL. This is a Safety Class 1 instrument (provided with terminal for connection to protective earth ground).

OPERATION. BEFORE APPLYING POWER verify that the product is set to match the available line voltage, the correct line fuse is installed, and all safety precautions (see following warnings) are taken. In addition, note the instrument's external markings described under "Safety Symbols".

WARNING.

- Servicing instructions are for use by service-trained personnel. To avoid dangerous electrical shock, do not perform any servicing unless you are qualified to do so.
- BEFORE SWITCHING ON THE INSTRUMENT, the protective earth terminal of the instrument must be connected to the protective conductor of the (mains) power cord. The mains plug shall be inserted only in an outlet socket that is provided with a protective earth contact. This protective action must not be negated by the use of an extension cord (power cable) that is without a protective conductor (grounding). Grounding one conductor of a two-conductor outlet is not sufficient protection.
- If this instrument is to be energized via an auto-transformer (for voltage change), make sure the common terminal is connected to the earth terminal of the power source.
- Any interruption of the protective (grounding) conductor (inside or outside the instrument), or disconnecting of the protective earth terminal will cause a potential shock hazard that could result in personal injury.
- Whenever it is likely that the protective earth connection has been impaired, this instrument must be made inoperative and be secured against any unintended operation.
- Only fuses with the required rated current, voltage, and specified type (normal blow, time delay, etc.) should be used. Do not use repaired fuses or short-circuited fuseholders. To do so could cause a shock or fire hazard.
- Do not operate this instrument in the presence of flammable gases or fumes.
- Do not install substitute parts or perform any unauthorized modification to this instrument.
- Some procedures described in this manual are performed with power supplied to the instrument while its protective covers are removed. If contacted, the energy available at many points may result in personal injury.
- Any adjustment, maintenance, and repair of this instrument while it is opened and under voltage should be avoided as much as possible. When this is unavoidable, such adjustment, maintenance, and repair should be carried out only by a skilled person who is aware of the hazard involved.
- Capacitors inside this instrument may hold a hazardous electrical charge even if the instrument has been disconnected from its power source.

SAFETY SYMBOLS.



Instruction manual symbol. The instrument will be marked with this symbol when it is necessary for you to refer to the instruction manual in order to protect against damage to the instrument.



This sign indicates hazardous voltages.

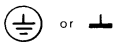



















This sign indicates an earth terminal (sometimes used in the manual to indicate circuit common connected to a ground chassis).

WARNING

The WARNING sign denotes a hazard. It calls attention to a procedure, practice, or the like, which, if not correctly performed or adhered to, could result in personal injury. Do not proceed beyond a WARNING sign until the indicated conditions are fully understood and met.

CAUTION

The CAUTION sign denotes a hazard. It calls attention to an operating procedure, or the like, which, if not correctly performed or adhered to, could result in damage to or destruction of part or all of the product. Do not proceed beyond a CAUTION sign until the indicated conditions are fully understood and met.

Safety Symbol Definitions			
Symbol	Description	Symbol	Description
	Direct current		Terminal for Line conductor on permanently installed equipment
	Alternating current		Caution, risk of electric shock
	Both direct and alternating current		Caution, hot surface
	Three-phase alternating current		Caution (refer to accompanying documents)
	Earth (ground) terminal		In position of a bi-stable push control
	Protective earth (ground) terminal (Intended for connection to external protective conductor.)		Out position of a bi-stable push control
	Frame or chassis terminal		On (supply)
	Terminal for Neutral conductor on permanently installed equipment		Off (supply)
	Terminal is at earth potential (Used for measurement and control circuits designed to be operated with one terminal at earth potential.)		Standby (supply) Units with this symbol are not completely disconnected from ac mains when this switch is off. To completely disconnect the unit from ac mains, either disconnect the power cord or have a qualified electrician install an external switch.

Printing History

The edition and current revision of this manual are indicated below. Reprints of this manual containing minor corrections and updates may have the same printing date. Revised editions are identified by a new printing date. A revised edition incorporates all new or corrected material since the previous printing date. Changes to the manual occurring between revisions are covered by change sheets shipped with the manual. Also, if the serial number prefix of your power supply is higher than those listed on the title page of this manual, then it may or may not include a change sheet. That is because even though the higher serial number prefix indicates a design change, the change may not affect the content of the manual.

Edition 1 April 1994
Edition 2 September, 2000

© Copyright 1993, 2000 Agilent Technologies, Inc.

This document contains proprietary information protected by copyright. All rights are reserved. No part of this document may be photocopied, reproduced, or translated into another language without the prior consent of Agilent Technologies, Inc. The information contained in this document is subject to change without notice.

Table of Contents

Introduction	7
Scope	7
Organization.....	7
Instrument Identification.....	7
Related Documents	8
Change Sheet.....	8
Operating Manual.....	8
Manual Revisions.....	8
Firmware Revisions	8
Safety Considerations	9
Conventions	9
Electrostatic Discharge	9
Verification.....	11
Introduction.....	11
Tests.....	11
Test Equipment Required	11
List of Equipment.....	11
Current-Monitoring Resistor	11
Electronic Load.....	12
Programming The Tests.....	13
General Considerations	13
Programming Parameters	13
General Measurement Techniques.....	13
Performance Test Record Sheets	13
Operation Verification Tests.....	14
Performance Tests.....	14
Constant Voltage (CV) Tests	14
Test Setup.....	14
Test Procedures	14
Constant Current (CC) Tests.....	19
Test Setup.....	19
Test Procedures	19
Averaging the CC Measurements	24
Troubleshooting.....	31
Introduction.....	31
Localizing the Problem	31
Chapter Organization	31
Test Equipment Required	32
Troubleshooting Procedures	32
Power-On Selftest	32
Description	32
Disabling The Power-On Selftest.....	32
Using the *TST? Query (GPIB Systems Supplies Only).....	32
Troubleshooting Charts.....	34
Troubleshooting Test Points	34
Bias and Reference Supplies.....	34
CV/CC Status Annunciators Troubleshooting	53
A3 FET Board Troubleshooting.....	53
Signature Analysis	56
Introduction.....	56
Firmware Revisions	56
Test Headers	57

Post-Repair Calibration.....	62
When Required	62
Inhibit Calibration Jumper	62
Calibration Password	62
Restoring Factory Calibration Constants	62
EEPROM Initialization.....	63
Transferring Calibration Constants To Factory Preset Locations	63
Disassembly Procedures	68
Tools Required.....	68
Top Cover	69
Removing Protective RFI Shield (Galvanized Sheet Metal).....	69
GPIB Board.....	69
A4 AC Input Assembly.....	70
A5 DC RAIL Assembly	70
A6 BIAS Assembly.....	70
A3 FET Board.....	70
A10 Control Assembly.....	71
Front Panel Assembly	71
S1 Line Switch.....	71
A1 Front Panel Board	71
A1DSP1 LCD Display.....	72
A1G1 and A1G2 Rotary Controls.....	72
A1KPD Keypad	72
Output Bus Boards A7, A81 and A9 & Chassis Components	72
Principles Of Operation	81
Introduction.....	81
A2 GPIB Board.....	81
A1 Front Panel Assembly	82
A10 Control Board.....	82
Secondary Interface (P/O A10 Board).....	82
A4 AC Input Board.....	85
A5 DC Rail Board.....	85
A3 FET Board.....	85
Output Circuits.....	86
Replaceable Parts	89
INTRODUCTION	89
Chapter Organization	89
Reading the Tables.....	89
How To Order Parts.....	90
Diagrams	115
Introduction.....	115
Chapter Organization.....	115
General Schematic Notes.....	119
Backdating.....	151
Index	157

Introduction

Scope

Organization

This manual contains information for troubleshooting and repairing to the component level Agilent Series 668xA, 5-kilowatt power supplies. The remaining chapters of this manual are organized as follows:

Chapter	Description
Chapter 2	Verification procedures to determine the performance level of the supply either before or after repair.
Chapter 3	Troubleshooting procedures for isolating a problem, procedures for replacing the defective component and, if required, post-repair calibration and EEPROM initialization procedures.
Chapter 4	Principles of power supply operation on a block-diagram level.
Chapter 5	Replaceable parts, including parts ordering information.
Chapter 6	Diagrams, including schematics, component location drawings, and troubleshooting test points.
Appendix A	Backdating information for power supplies with serial numbers below those listed in the title page of this manual.

Instrument Identification

Agilent Technologies instruments are identified by a 10-digit serial number. The format is described as follows: first two letters indicate the country of manufacture. The next four digits are a code that identify either the date of manufacture or of a significant design change. The last four digits are a sequential number assigned to each instrument.

Item	Description
US	The first two letters indicates the country of manufacture, where US = USA.
3648	This is a code that identifies either the date of manufacture or the date of a significant design change.
0101	The last four digits are a unique number assigned to each power supply.

If the serial number prefix on your unit differs from that shown on the title page of this manual, a yellow Manual Change sheet may be supplied with the manual. It defines the differences between your unit and the unit described in this manual. The yellow change sheet may also contain information for correcting errors in the manual.

Older serial number formats used with these instruments had a two-part serial number, i.e. 2701A-00101. This manual also applies to instruments with these older serial number formats. Refer to Appendix A for backdating information.

Related Documents

Change Sheet

There may or may not be a *Manual Change* sheet included with this manual (see Manual Revisions). If one is included, be sure to examine it for changes to this manual.

Operating Manual

Each power supply is shipped with an operating manual (see Replaceable Parts, Chapter 5 for part numbers) that covers the following topics:

- Options, accessories, specifications, supplementary characteristics, output characteristic curve, typical output impedance curves.
- Connecting the power cord, load, and remote sensing.
- Connecting power supplies in series or autoparallel.
- Connecting the remote controller and setting the GPIB address.
- Configuring the digital port for remote inhibit, relay link, or digital I/O operation.
- Connecting the analog port for external voltage programming control.
- Turn-on tests, including selftest errors and runtime errors.
- Front panel operation.
- SCPI programming, an introduction to syntax, language dictionary, and status register operation.
- Compatibility-language programming for operation with Agilent Series 603xA power supplies.
- Replacement of line fuse and conversion of line voltage.
- Calibration procedure (front panel and remote).

Manual Revisions

This manual was written for power supplies that have the same serial prefixes (first part) as those listed on the title page and whose serial numbers (second part) are equal to or higher than those listed in the title page.

Note

- 1) If the serial prefix of your supply is higher than that shown in the title page then the supply was made after the publication of this manual and may have hardware and/or firmware differences not covered in the manual.
 - 2) If they are significant to the operation and/or servicing of the power supply, those differences are documented in one or more Manual Changes sheets included with this manual.
 - 3) If the serial prefix on the power supply is lower than that shown on the title page, then the supply was made before the publication of this manual and can be different from that described here. Such differences are covered in "Appendix A – Manual Backdating Changes".
-

Firmware Revisions

The power supply's firmware resides in the A10 control board microprocessor chip and in ROM chips on the A2 GPIB and A1 Front Panel boards. You can obtain the firmware revision number by either reading the integrated circuit label, or query the power supply using the GPIB *IDN query command (see Chapter 3 - Troubleshooting). Also, see Chapter 3, Firmware Revisions for the actual Agilent BASIC program that does this.

Safety Considerations

This power supply is a Safety Class I instrument, which means it has a protective earth terminal. This terminal must be connected to earth ground through a power source equipped with a 4-wire, ground receptacle. Refer to the "Safety Summary" page at the beginning of this manual for general safety information. Before operation or repair, check the power supply and review this manual for safety warnings and instructions. Safety warnings for specific procedures are located at appropriate places in the manual.

WARNING

Hazardous voltage exist within the power supply chassis, at the output terminals, and at the analog programming terminals.

Conventions

- In diagrams, the name of a complementary signal is sometimes shown with a bar above the signal mnemonic. In other diagrams and in the text, complementary signals are shown with an asterisk (*) after the mnemonic (such as PCLR*). A mnemonic with a bar over it or an asterisk after it represents the same signal.
- In this manual, all Agilent 668xA series supplies are referred to as *system* supplies.

Electrostatic Discharge

CAUTION

The power supply has components that can be damaged by ESD (electrostatic discharge). Failure to observe standard, antistatic practices can result in serious degradation of performance, even when an actual failure does not occur.

When working on the power supply observe all standard, antistatic work practices. These include, but are not limited to:

- working at a static-free station such as a table covered with static-dissipative laminate or with a conductive table mat (Agilent P/N 9300-0797, or equivalent).
- using a conductive wrist strap, such as Agilent P/N 9300-0969 or 9300-0970.
- grounding all metal equipment at the station to a single common ground.
- connecting low-impedance test equipment to static-sensitive components only when those components have power applied to them.
- removing power from the power supply before removing or installing printed circuit boards.

Verification

Introduction

This chapter provides test procedures for checking the operation of Agilent Series 668xA power supplies. The required test equipment is specified and sample performance test record sheets are included. Instructions are given for performing the tests either from the front panel or from a controller over the GPIB.

Tests

Two types of procedures are provided: Operation Verification tests and Performance tests.

Type of Test	Purpose
Operation Verification	These tests do not check all parameters, but comprise a short procedure to verify that the power supply is performing properly.
Performance	These tests verify all the Specifications (not Supplementary Characteristics) listed in Table 1-1 of the Power Supply Operating Manual.

If you encounter failures or out-of-specification test results, see Troubleshooting Procedures (Chapter 3). The procedures will determine if repair and/or calibration is required.

Note The power supply must pass the selftest at power-on before the following tests can be performed. If the power supply fails selftest, go to Chapter 3.

Test Equipment Required

List of Equipment

Table 2-1 lists the equipment required to perform the tests given in this chapter. Only the equipment marked with the superscript "1" is needed for the Operation Verification test.

Current-Monitoring Resistor

The four-terminal, current-monitoring resistor (current shunt) listed in Table 2-1 is required to eliminate output current measurement error caused by voltage drops in leads and connections. The specified current shunts have special current-monitoring terminals inside the load connection terminals. The accuracy of the current shunt must be 0.04% or better. When using the 1000 amp 0.05% current shunt the measurement uncertainty should be stated for all calibrations. Connect the current monitor directly to these current-monitoring terminals.

Table 2-1. Test Equipment Required

Type	Required Characteristics	Recommended Model
Digital Voltmeter¹	Resolution: 10 nV @ 1V Readout: 8 1/2 digits Accuracy: 20 ppm	Agilent 3458A
Current Monitor Resistor¹	Agilent 6682A, 6683A, Agilent 6684A: 0.001Ω ± 0.04%, 300A, 100W Agilent 6680A, 6681A 100 μΩ ± 0.05%, 1000A	Guildline 9230/300 Burster Type 1280
DC Power Supply	DC Power Source with current capability equal to UUT	Agilent 6680A
Electronic Load Resistor Load	Range: Voltage and current range must exceed that of supply under test. Power: 5.4KW minimum or 5 Kilowatt minimum Agilent 6680A = 5.7 milliohms 4375W Agilent 6681A = 13.8 milliohms 4640W Agilent 6682A = 87.5 milliohms. 5040W Agilent 6683A = 200 milliohms 5120W Agilent 6684A = 312 milliohms 5120W	3 each Agilent 6050A, w/3 each Agilent 60504B per Agilent 6050A for all units
Oscilloscope	Sensitivity: 1mV Bandwidth Limit: 20MHz Probe: 1:1 with RF tip	Agilent 54504A
RMS Voltmeter	True RMS Bandwidth: 20MHz Sensitivity: 100 μV	Agilent 3400B
Current Transformer	0.1Volt per ampere: 1Hz to 20MHz	Pearson Model 411
Variable-Voltage Transformer (AC Source)	Power: 3 Phase 24KVA; Range: 180-235V 47 - 63Hz; 360- 440V 47 - 63Hz	Superior Powerstat 1156DT-3Y, 0-280V, 50A, 24.2 KVA or equivalent .
GPIB Controller²	Full GPIB capabilities	HP Series 200/300
¹ Required for Operation Verification Tests. ² Required for remote testing of 668xA models.		

Electronic Load

Many of the test procedures require the use of a variable load capable of dissipating the required power. If a variable resistor is used, switches must be used for connecting, disconnecting, and shorting the load resistor. For most tests, an electronic load (see Table 2-1) is easier to use than a variable resistor. However, an electronic load may not be fast enough for testing transient recovery time or may be too noisy for testing noise (PARD). In these cases, fixed load resistors of suitable power dissipation can be used with minor changes to the test procedures given in this chapter.

Programming The Tests

General Considerations

Procedures are given for programming these tests either from the front panel keypad or from a GPIB controller. The procedures assume you know how to use the front panel keypad or how to program over the GPIB (see the Power Supply Operating Manual for more information). When using computer-controlled tests, you may have to consider the relatively slow (compared to computer and system voltmeters) settling times and slew rates of the power supply. Suitable WAIT statements can be inserted into the test program to give the power supply time to respond to the test commands.

WARNING

This power supply can provide more than 240VA at more than 2 volts. If the output connections touch each other, severe arcing can occur resulting in burns, ignition or welding of parts. **DO NOT ATTEMPT TO MAKE CONNECTIONS WHILE OUTPUT POWER IS ON.** These connections should be performed only by qualified electronics personnel.

Programming Parameters

Table 2-2 lists the programming voltage and current values for each model. You can enter these values either from the front panel or from a controller over the GPIB.

Table 2-2. Programming Voltage and Current Values

Agilent Model	Full Scale Voltage	Max. Prog. Voltage	Full Scale Current	Max. Prog. Current	Max. Prog. Overvoltage
Agilent 6680A	5V	5.125V	875A	895A	6.25V
Agilent 6681A	8V	8.190V	580A	592A	10.0V
Agilent 6682A	21V	21.50V	240A	246A	25.2V
Agilent 6683A	32V	32.75V	160A	164A	38.4V
Agilent 6684A	40V	41.00V	128A	131A	48.0V

General Measurement Techniques

Figure 2-1 shows the setup for the Constant Voltage tests. Measure the dc output voltage directly at the sense (+S and -S) terminals. Connect these terminals for remote sensing (to the +S and -S terminals). Connect these terminals for local sensing. Be certain to use load leads of sufficient wire gauge to carry the output current (see Chapter 4 of the Power Supply Operating Manual). To avoid noise pickup, use coaxial cable or shielded pairs for the test leads. If you use more than one meter or a meter and an oscilloscope, connect separate leads for each instrument to avoid mutual-coupling effects.

Performance Test Record Sheets

When performing the tests in this chapter, refer to the Performance Test Record sheets supplied at the end of this chapter. Table 2-6 is for recording common information, such as, the test equipment used and the environmental conditions. Tables 2-7 through 2-11 are dedicated to specific models. Each sheet lists the acceptable test ranges for the model and provides a place to record the results of the test.

Note

It is recommended that before you perform the tests in either Table 2-4 or Table 2-5, that you first locate the appropriate Performance Test Record sheet from Tables 2-7 through Table 2-11 for your specific model. Make a copy of this sheet, and record the actual observed values in it while performing the tests. Use the sheets in Tables 2-7 through Table 2-11 as master reference sheets to run copies at any time.

Operation Verification Tests

Table 2-3 lists the requirements for operation verification, which is a subset of the performance tests.

Table 2-3. Operation Verification Tests

Test	Refer To
1 Turn-On Checkout	Power Supply Operating Manual
2 Voltage Programming and Readback Accuracy	Table 2-4
3 Current Programming and Readback Accuracy	Table 2-5

Note: Record the results of Tests 2 and 3 in the appropriate Performance Test Record sheets

Performance Tests

Performance tests check all the specifications of the power supply. The tests are grouped into constant-voltage mode tests (Table 2-4) and constant-current mode tests (Table 2-5).

Constant Voltage (CV) Tests

Test Setup

Connect your dc voltmeter leads to only +S and -S (see Figure 2-1), because the power supply regulates the voltage between these points, not between the + and - output terminals .

Test Procedures

Perform the test procedures in Table 2-4. The CV tests are:

- Voltage Programming and Readback Accuracy
- CV Load Effect
- CV Source Effect
- CV Noise (PARD)
- Transient Recovery Time

Note The tests are independent and may be performed in any order.

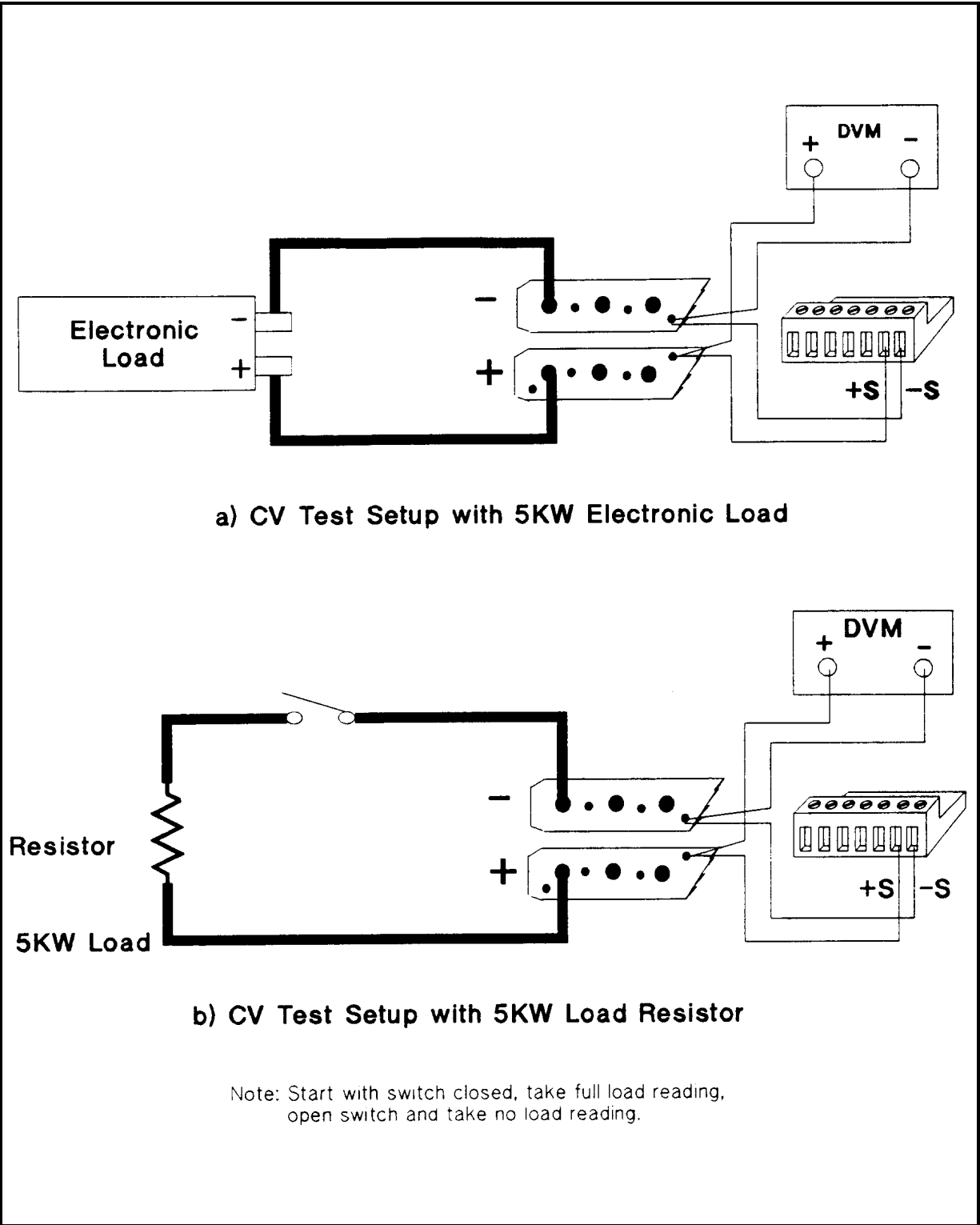

Figure 2-1. Constant Voltage (CV) Test Setup

Table 2-4. Constant Voltage (CV) Tests

	Action	Normal Result
Voltage Programming and Readback Accuracy		
<p>This test verifies that the voltage programming, GPIB readback (GPIB system power supplies only), and front panel display functions are within specifications. With system power supplies, values read back over the GPIB should be the same as those displayed on the front panel.</p>		
1	Turn off the power supply and connect a DVM across +S and -S (see Fig. 2-1).	
2	Turn on the power supply with no load and program the output for 0 volts and maximum programmable current (see Table 2-2).	CV annunciator on. Output current near 0.
3	Record voltage readings at DVM and on front panel display.	Readings within specified Low Voltage limits.
4	Program voltage to full scale (see Table 2-2).	
5	Record voltage readings of DVM and on front panel display.	Readings within specified High Voltage limits.
CV Load Effect		
<p>This test measures the change in output voltage resulting from a change in output current from full-load to no-load.</p>		
1	Turn off the power supply and connect a DVM across +S and -S (see Fig. 2-1).	
2	Turn on the power supply and program the current to its maximum programmable value and the voltage to its full-scale value (see Table 2-2).	
3	Adjust the load to produce full-scale current (see Table 2-2) as shown on the front panel display.	CV annunciator is on. If it is not, adjust the load to slightly reduce the output current until the annunciator comes on.
4	Record voltage reading of the DVM.	
5	Adjust load to draw 0 amperes (open load). Record voltage reading of the DVM.	
6	Check test result.	The difference between the DVM readings in steps 4 and 5 are within the specified Load Effect limits.
CV Source Effect		
<p>This test measures the change in output voltage resulting from a change in ac line voltage from its minimum to maximum value within the line voltage specifications.</p>		
1	Turn off the power supply and connect the ac power input through a variable-voltage transformer.	

Table 2-4. Constant Voltage (CV) Tests (continued)

	Action	Normal Result
CV Source Effect (cont)		
2	Set the transformer to the nominal ac line voltage. Connect the DVM across +S and -S (see Fig. 2-1).	
3	Turn on the power supply and program the current to its maximum programmable value and the voltage to its full-scale value (see Table 2-2).	
4	Adjust the load to produce full-scale current (see Table 2-2) as shown on the front panel display.	CV annunciator is on. If it is not, adjust the load to slightly reduce the output current until the annunciator comes on.
5	Adjust the transformer to decrease the ac input voltage to the low- line condition (174Vac or 191Vac). Record the output voltage reading of the DVM.	
6	Adjust the transformer to increase the ac input voltage to the high-line condition (220Vac or 250Vac). Record the output voltage reading on the DVM.	
7	Check test result.	The difference between the DVM readings in steps 5 and 6 are within the specified Source Effect limits.
CV Noise (PARD)		
Periodic and random deviations (PARD) in the output (ripple and noise) combine to produce a residual ac voltage superimposed on the dc output voltage. This test measures CV PARD, specified as the rms and peak-to-peak output voltages over the frequency range of 20Hz to 20MHz.		
1	Turn off the power supply and connect an a-c coupled oscilloscope across the + and -output terminals (see Fig. 2-1). Set the oscilloscope bandwidth limit to 20MHz (30MHz for the Agilent 54504A) and use an RF tip on the oscilloscope probe.	
2	Turn on the power supply and program the current to its maximum programmable value and the voltage to its full-scale value (see Table 2-2).	
3	Adjust the load to produce full-scale current (see Table 2-2) as shown on the front panel display.	CV annunciator is on. If it is not, adjust the load to slightly reduce the output current until the annunciator comes on.
4	Record the amplitude of the waveform.	
5	Replace the oscilloscope connection with an ac rms voltmeter.	Amplitude is within the specified PARD Peak-to-Peak limits.
6	Record the reading obtained in Step 5.	Amplitude is within the specified PARD rms limits.

Table 2-4. Constant Voltage (CV) Tests (continued)

	Action	Normal Result
Transient Recovery Time		
<p>This test measures the time required for the output voltage to return to within 100mV of its final value following a 50% change in output load current. Measurements are made on both the unloading transient (from full load to 1/2 load) and the loading transient (from 1/2 load to full load).</p>		
1	Turn off the power supply and connect an oscilloscope across +S and -S (see Fig. 2-1).	
2	Turn on the power supply and program the current to its maximum programmable value and the voltage to its full-scale value (see Table 2-2).	
3	Program the Electronic Load as follows: <ul style="list-style-type: none"> ↳ Operating mode to constant current. ↳ Input load current to 1/2 the supply's full rated output current. ↳ Transient current level to the supply's full rated output current. ↳ Transient generator frequency = 100Hz. ↳ Transient generator duty cycle = 50%. 	
4	Turn on the transient and adjust the oscilloscope to display response waveform.	See Fig. 2-2.
5	Measure both the loading and unloading transients by triggering the oscilloscope on both the negative and positive slopes of the transient. Record the voltage level obtained at the 900- μ s interval .	Specified voltage level is reached within 900 μ s.

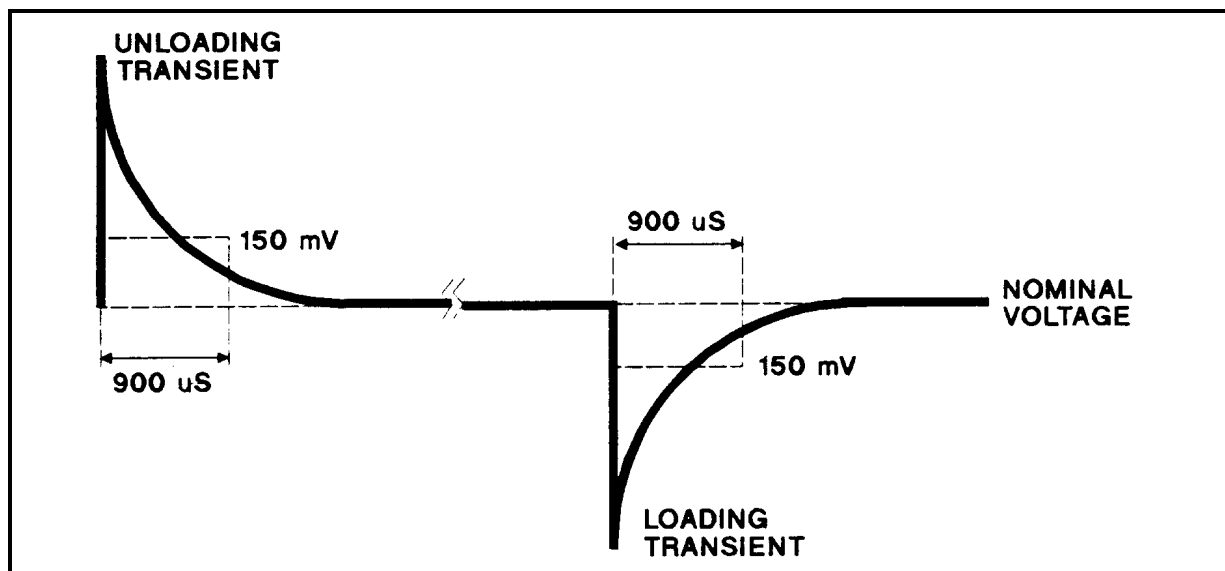

Figure 2-2. Transient Response Waveform

Constant Current (CC) Tests

Test Setup

Connect the appropriate current monitoring resistor (see Table 2-1) as shown in Fig. 2-3. The accuracy of the resistor must be as specified in the table.

Test Procedures

The test procedures are given in Table 2-5. The tests are independent and may be performed in any order. The CC tests are:

- Current Programming and Readback Accuracy.
- CC Load Effect.
- CC Source Effect.
- CC Noise (PARD).

Table 2-5. Constant Current (CC) Tests

	Action	Normal Result
Current Programming and Readback Accuracy		
This test verifies that the current programming and readback are within specification.		
1	Turn off the power supply and connect the current monitoring resistor as shown in Fig. 2-3. Connect a DVM across the resistor .	
2	Turn on the power supply and program the output for 5 volts and 0 amperes.	
3	Short the load.	
4	Observe the DVM voltage reading. Divide this by the resistance of the current monitor resistor. Record the result as the Low Current value.	Value within specified Low Current limits.
5	Record the front panel display readback.	Value within specified readback limits.
6	Program output current to full scale (see Table 2-2).	
7	Repeat Steps 4 and 5.	Both current readings within specified High Current and readback limits.
CC Noise (PARD)		
Periodic and random deviations (PARD) in the output (ripple and noise) combine to produce a residual ac current superimposed on the dc output current. This test measures CC PARD, specified as the rms output current over the frequency range of 20 Hz to 20 MHz.		
1	Turn off the power supply and connect the current transformer, resistor, capacitor and rms voltmeter (see Fig. 2-4).	

Table 2-5. Constant Current (CC) Tests (continued)

	Action	Normal Result
CC Noise (PARD) (cont)		
2	Measure the residual noise on the DVM with the power supply turned off. Noise generated by other equipment may affect this measurement and should be removed or factored out.	
3	Turn on the power supply and program the current to its full scale value and the voltage to its maximum programmable value (see Table 2-2).	
4	Adjust the load in the CV mode for full-scale voltage (see Table 2-2) as shown on the front panel display.	The power supply output current should be at its full-scale value and the CC annunciator on. If it is not, adjust the load to slightly reduce the output voltage until the annunciator comes on.
5	Observe the reading on the rms voltmeter. Multiply rms voltage by 0.1 to obtain the rms noise current.	Current is within the specified PARD rms limits (see Table 2-6).
CC Load Effect		
<p>This test measures the change in output current resulting from a change in load from full-load voltage to a short circuit. It is recommended that you use averaged readings for Steps 5 and 6 of this test (see Averaging AC Measurements at the end of this chapter).</p>		
<p>Note: Refer to Figure 2-4. If you are using Agilent 60504B Eloads, a series DC power source is required to supply the minimum 3 volt input required by the Agilent 60504B Eloads. The series DC source must be capable of 3VDC at a current level greater than the output current of the supply being tested. A switch can be used in place of the series supply if the Eloads are used in place of a load resistor as shown in Fig. 2-4(b).</p>		
1	Turn off the power supply and connect a DVM across the current monitoring resistor (see Fig. 2-3).	
2	Turn on the power supply and program the current to its full scale value and the voltage to its maximum programmable value (see Table 2-2).	
3	Set the Electronic Load to CV mode and its voltage to full scale as indicated on its front panel display. Set the series supply for 3VDC and a current greater than that being tested. Series source should be in CV mode.	Power supply output current is full scale and its CC annunciator is on. If not, reduce the Electronic Load voltage slightly until the annunciator comes on.
4	Observe the DVM reading. Divide this by the resistance of the current monitoring resistor to obtain the output current. Record the result.	You may want to use an averaged reading for this measurement.
5	Program the Electronic Load input to 3 volts or short the Electronic Load input and repeat Step 5.	You may want to use averaged reading for this measurement.
6	Check the result.	The difference between the current readings taken in Step 5 and Step 6 must be within specified "Load Effect" limits (see Table 2-2).

Table 2-5. Constant Current (CC) Tests (continued)

	Action	Normal Result
CC Source Effect		
<p>This test measures the change in output current resulting from a change in ac line voltage from its minimum to its maximum value within the line voltage specifications. It is recommended that you use averaged readings for Steps 6 and 8 of this test (see "Averaging AC Measurements" at the end of this chapter) .</p>		
1	Turn off the power supply and connect the ac power input through a variable-voltage transformer.	
2	Set the transformer to the nominal ac line voltage. Connect the DVM across the current monitoring resistor (see Fig. 2-3).	
3	Turn on the power supply and program the current to its full-scale value and the voltage to its maximum programmable value (see Table 2-2).	
4	Set the Electronic Load to CV mode and its voltage to full scale.	The power supply output current is full scale and its CC annunciator is on. If not, reduce the Electronic Load voltage slightly until the annunciator comes on.
5	Adjust the transformer to decrease the ac input voltage to the low-line condition (180Vac or 360Vac).	
6	Observe the DVM reading. Divide this voltage by the resistance of the current monitoring resistor to obtain the output current. Record the result.	You may want to use an averaged reading for this measurement.
7	Adjust the transformer to increase the ac input voltage to the high-line condition (235Vac or 440Vac).	
8	Observe the DVM reading. Divide this voltage by the resistance of the current monitoring resistor to obtain the output current. Record the result.	You may want to use an averaged reading for this measurement.
9	Check the test result.	The difference between the current readings found in Step 6 and Step 8 is within the specified current Source Effect limits.

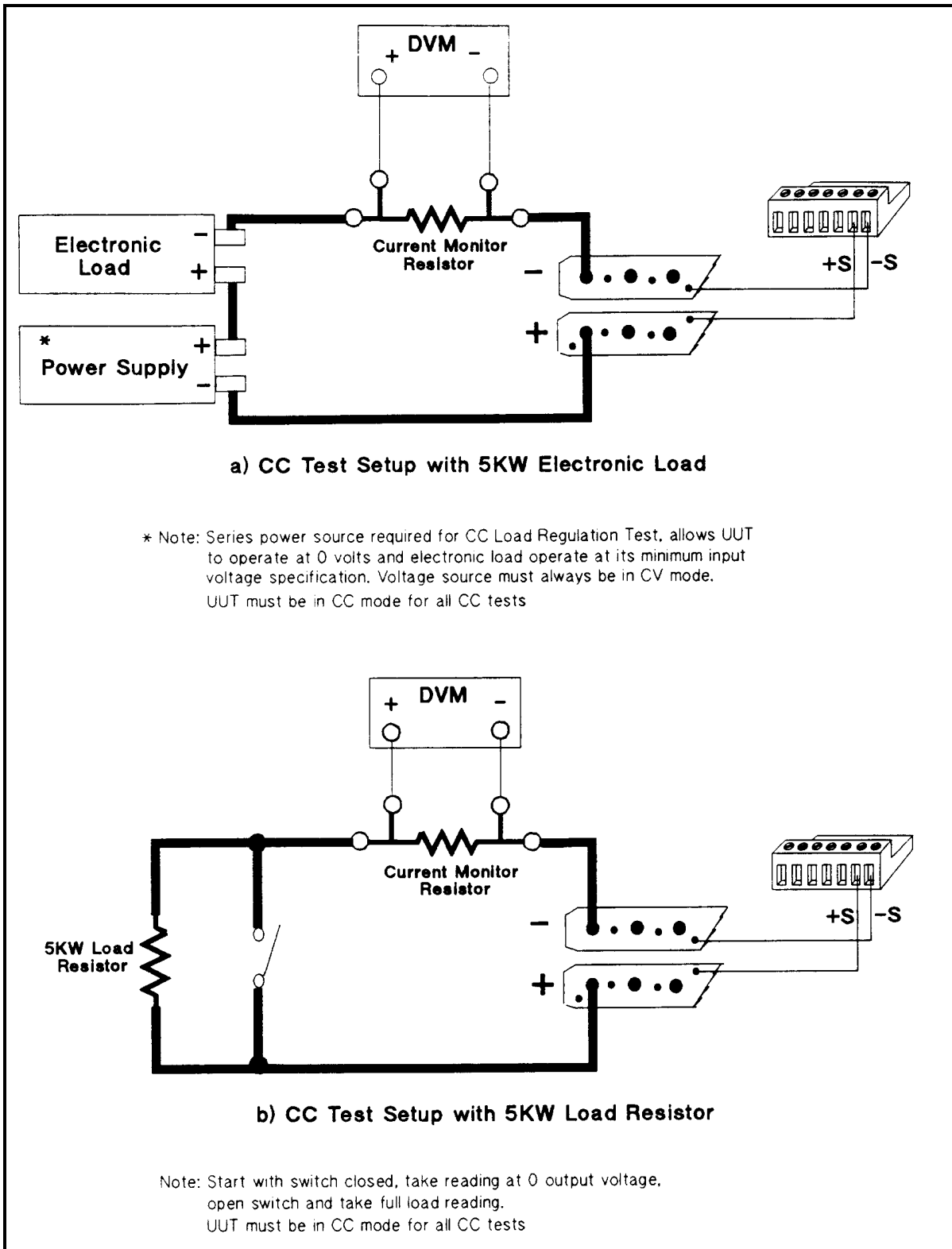
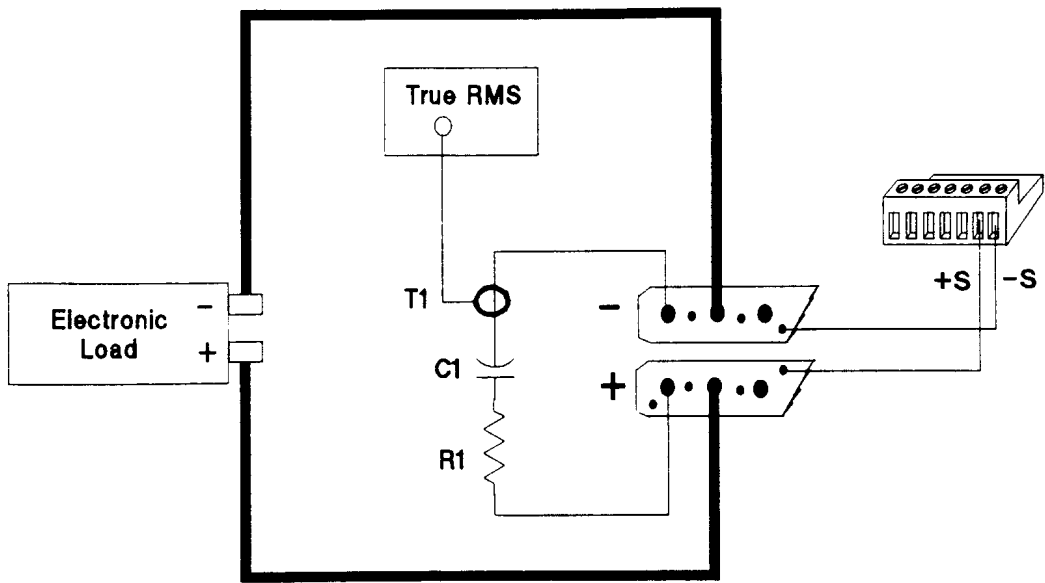

Figure 2-3. CC Load Effect Test Setup



	R1	C1	R1 / C1 construction
6680A	4.0 milliohms	132,000 uF	4 * 33,000uF (0180-4516) + 2 ea. 7 inch 12 AWG leads
6681A	6.0 milliohms	88,000 uF	4 * 22,000 uF (0180-4532) + 2 ea. 7 inch 14 AWG leads
6682A	4.42 milliohms	36,000 uF	5 * 7200 uF (0180-4597) + 2 ea. 8 inch 10 AWG leads
6683A	6.12 milliohms	26,000 uF	2 * 13,000 uF (0180-4596) + 2 ea. 6 inch 10 AWG leads
6684A	11.1 milliohms	14,400 uF	2 * 7200 uF (0180-4597) + 2 ea. 11 inch 14 AWG leads

1. T1 = Pearson Type 411 (see Table 2-1).
2. R1 = ESR of capacitor + wire lead resistance.
3. Parallel capacitor connections should be made with copper sheet and wire leads should be soldered to copper sheet to reduce series resistance.
4. Fixed load resistor may be used in place of electronic load.
5. Electronic load consists of: 11-60504Bs in CC mode and 1-60504B in CR mode for the 6680A / 6681A.
12-60504Bs in CR mode for the 6682A / 6683A / 6684A.





Figure 2-4. CC rms Noise Test Setup

Averaging the CC Measurements

The CC Load Effect and CC Source Effect tests measure the dc regulation of the power supply's output current. When doing these tests, you must be sure that the readings taken are truly dc regulation values and not instantaneous ac peaks of the output current ripple. You can do this by making each measurement several times and then using the average of the measurements as your test value. Voltmeters such as the Agilent 3458A System Voltmeter can be programmed to take just such statistical average readings as required by these tests.

The following steps show how to set up the voltmeter from its front panel to take a statistical average of 100 readings.

 represents the unlabeled shift key in the FUNCTION/RANGE group.

1. Program 10 power line cycles per sample by pressing **NPLC** **1** **0** **Enter**.
2. Program 100 samples per trigger by pressing **N Rds/Trig** **1** **0** **0** **Enter**.
3. Set up voltmeter to take measurements in the statistical mode as follows:
 - a. Press  **f0**  **N**.
 - b. Press **▲** until MATH function is selected, then press **▶**.
 - c. Press **▲** until STAT function is selected, then press **Enter**.
4. Now set up voltmeter to read the average of the measurements as follows:
 - a. Press  **f1**  **N**.
 - b. Press **▼** until RMATH function is selected, then press **Enter**.
 - c. Press **▲** until MEAN function is selected, then press **Enter**.
5. Execute the average reading program by pressing **f0** **Enter** **TRIG** **Enter**.
6. Wait for 100 readings and then read the average measurement by pressing **f1** **Enter**.

Record this as your result.

Table 2-6. Performance Test Record Form

Test Facility:

 Model _____
 Serial No. _____
 Options _____
 Firmware Revision _____

Report No. _____
 Date _____
 Customer _____
 Tested By _____
 Ambient Temperature (°C) _____
 Relative Humidity (%) _____
 Nominal Line Frequency (Hz) _____

Special Notes:

Test Equipment Used:

Description	Model No.	Trace No.	Cal. Due Date
1. AC Source	_____	_____	_____
2. DC Voltmeter	_____	_____	_____
3. RMS Voltmeter	_____	_____	_____
4. Oscilloscope	_____	_____	_____
5. Electronic Load	_____	_____	_____
6. Current Monitoring Shunt	_____	_____	_____

Table 2-7. Performance Test Record for Agilent Model 6680A

MODEL Agilent _____	Report No. _____		Date _____	
Test Description	Minimum Spec.	Results *	Maximum Spec.	Measurement Uncertainty
Constant Voltage Tests				
Voltage Programming and Readback				
Low Voltage (0V) V_{out} Front Panel Display Readback	-5mV $V_{out} - 7.5mV$	_____mV _____mV	+5mV $V_{out} + 7.5mV$	1.6 μV 1.6 μV
High Voltage (5V) V_{out} Front Panel Display Readback	4.993V $V_{out} - 10mV$	_____V _____mV	5.007V $V_{out} + 10mV$	56 μV 56 μV
Load Effect	$V_{out} - 0.3mV$	_____mV	$V_{out} + 0.3mV$	750 nV
Source Effect	$V_{out} - 0.3mV$	_____mV	$V_{out} + 0.3mV$	750 nV
PARD (Ripple and Noise)				
Peak-to-Peak	0	_____mV	10mV	904 μV
RMS	0	_____mV	1.5mV	150 μV
Transient Response Time (at 900 μs)	0	_____mV	150mV	23mV
Constant Current Tests				
Current Programming and Readback				
Low Current (0A) I_{out} Front Panel Display Readback	-450mA $I_{out} - 600mA$	_____mA _____mA	+450mA $I_{out} + 600mA$	15 μA 15 μA
High Current (875A) I_{out} Front Panel Display Readback	873.675A $I_{out} - 1.475mA$	_____A _____mA	+876.325A $I_{out} + 1.475mA$	462mA 462mA
PARD (Ripple and Noise) RMS	0	_____mA	290mA	3.8mA
Load Effect	$I_{out} - 108mA$	_____mA	$I_{out} + 108mA$	937 μA
Source Effect	$I_{out} - 108mA$	_____mA	$I_{out} + 108mA$	937 μA
*Enter your test results in this column.				

Table 2-7. Performance Test Record for Agilent Model 6681A

MODEL Agilent _____	Report No. _____		Date _____	
Test Description	Minimum Spec.	Results *	Maximum Spec.	Measurement Uncertainty
Constant Voltage Tests				
Voltage Programming and Readback				
Low Voltage (0V) V_{out} Front Panel Display Readback	-8mV $V_{out} - 12mV$	_____mV _____mV	+8mV $V_{out} + 12mV$	1.6 μV 1.6 μV
High Voltage (8V) V_{out} Front Panel Display Readback	7.988V $V_{out} - 16mV$	_____V _____mV	8.011V $V_{out} + 16mV$	88 μV 88 μV
Load Effect	$V_{out} - 0.5mV$	_____mV	$V_{out} + 0.5mV$	900 nV
Source Effect	$V_{out} - 0.5mV$	_____mV	$V_{out} + 0.5mV$	900 nV
PARD (Ripple and Noise)				
Peak-to-Peak	0	_____mV	10mV	904 μV
RMS	0	_____mV	1.5 mV	150 μV
Transient Response Time (at 900 μs)	0	_____mV	150mV	23mV
Constant Current Tests				
Current Programming and Readback				
Low Current (0A) I_{out} Front Panel Display Readback	-300mA $I_{out} - 400mA$	_____mA _____mA	+300mA $I_{out} + 400mA$	15mA 15mA
High Current (580A) I_{out} Front Panel Display Readback	579.120A $I_{out} - 980mA$	_____A _____A	+580.880A $I_{out} + 980mA$	311mA 311mA
PARD (Ripple and Noise)				
RMS	0	_____mA	190mA	3.8mA
Load Effect	$I_{out} - 69mA$	_____mA	$I_{out} + 69mA$	790 μA
Source Effect	$I_{out} - 69mA$	_____mA	$I_{out} + 69mA$	790 μA
*Enter your test results in this column.				

Table 2-7. Performance Test Record for Agilent Model 6682A

MODEL Agilent _____	Report No. _____		Date _____	
Test Description	Minimum Spec.	Results *	Maximum Spec.	Measurement Uncertainty
Constant Voltage Tests				
Voltage Programming and Readback				
Low Voltage (0V) V_{out} Front Panel Display Readback	-21mV $V_{out} - 32mV$	_____mV _____mV	+21mV $V_{out} + 32mV$	1.7 μV 1.7 μV
High Voltage (21V) V_{out} Front Panel Display Readback	20.970V $V_{out} - 42mV$	_____V _____mV	21.029V $V_{out} + 42mV$	347 μV 347 μV
Load Effect	$V_{out} - 1mV$	_____mV	$V_{out} + 1mV$	20 μV
Source Effect	$V_{out} - 1mV$	_____mV	$V_{out} + 1mV$	20 μV
PARD (Ripple and Noise)				
Peak-to-Peak	0	_____mV	10mV	904 μV
RMS	0	_____mV	1.75 mV	150 μV
Transient Response Time (at 900 μs)	0	_____mV	150mV	23 μV
Constant Current Tests				
Current Programming and Readback				
Low Current (0A) I_{out} Front Panel Display Readback	-125mA $I_{out} - 165mA$	_____mA _____mA	+125mA $I_{out} + 165mA$	1.5mA 1.5mA
High Current (240A) I_{out} Front Panel Display Readback	239.635A $I_{out} - 405mA$	_____A _____mA	+240.365A $I_{out} + 405mA$	84mA 84mA
PARD (Ripple and Noise)				
RMS	0	_____mA	80mA	0.8mA
Load Effect	$I_{out} - 24mA$	_____mA	$I_{out} + 24mA$	172 μA
Source Effect	$I_{out} - 24mA$	_____mA	$I_{out} + 24mA$	172 μA
*Enter your test results in this column.				

Table 2-7. Performance Test Record for Agilent Model 6683A

MODEL Agilent _____	Report No. _____		Date _____	
Test Description	Minimum Spec.	Results *	Maximum Spec.	Measurement Uncertainty
Constant Voltage Tests				
Voltage Programming and Readback				
Low Voltage (0V) V_{out} Front Panel Display Readback	-32mV $V_{out} - 48mV$	_____mV _____mV	+32mV $V_{out} + 48mV$	1.9 μV 1.9 μV
High Voltage (32V) V_{out} Front Panel Display Readback	31.995V $V_{out} - 64mV$	_____V _____mV	32.044V $V_{out} + 64mV$	488 μV 488 μV
Load Effect	$V_{out} - 1.7mV$	_____mV	$V_{out} + 1.7mV$	26 μV
Source Effect	$V_{out} - 1.7mV$	_____mV	$V_{out} + 1.7mV$	26 μV
PARD (Ripple and Noise)				
Peak-to-Peak	0	_____mV	10mV	904 μV
RMS	0	_____mV	2.0mV	150 μV
Transient Response Time (at 900 μs)	0	_____mV	150mV	23 μV
Constant Current Tests				
Current Programming and Readback				
Low Current (0A) I_{out} Front Panel Display Readback	-85mA $I_{out} - 110mA$	_____mA _____mA	+85mA $I_{out} + 110mA$	1.5mA 1.5mA
High Current (160A) I_{out} Front Panel Display Readback	159.755A $I_{out} - 270mA$	_____A _____mA	+160.245A $I_{out} + 270mA$	36mA 36mA
PARD (Ripple and Noise) RMS	0	_____mA	55mA	0.56mA
Load Effect	$I_{out} - 18mA$	_____mA	$I_{out} + 18mA$	148 μA
Source Effect	$I_{out} - 18mA$	_____mA	$I_{out} + 18mA$	148 μA
*Enter your test results in this column.				

Table 2-7. Performance Test Record for Agilent Model 6684A

MODEL Agilent _____	Report No. _____		Date _____	
Test Description	Minimum Spec.	Results *	Maximum Spec.	Measurement Uncertainty
Constant Voltage Tests				
Voltage Programming and Readback				
Low Voltage (0V) V_{out} Front Panel Display Readback	-40mV $V_{out} - 60mV$	_____mV _____mV	+40mV $V_{out} + 60mV$	2 μV 2 μV
High Voltage (40V) V_{out} Front Panel Display Readback	39.944V $V_{out} - 80mV$	_____V _____mV	40.056V $V_{out} + 80mV$	590 μV 590 μV
Load Effect	$V_{out} - 2.3mV$	_____mV	$V_{out} + 2.3mV$	30 μV
Source Effect	$V_{out} - 2.3mV$	_____mV	$V_{out} + 2.3mV$	30 μV
PARD (Ripple and Noise)				
Peak-to-Peak	0	_____mV	10mV	904 μV
RMS	0	_____mV	2.5mV	150 μV
Transient Response Time (at 900 μs)	0	_____mV	150mV	23 μV
Constant Current Tests				
Current Programming and Readback				
Low Current (0A) I_{out} Front Panel Display Readback	-65mA $I_{out} - 90mA$	_____mA _____mA	+65mA $I_{out} + 90mA$	1.5mA 1.5mA
High Current (128A) I_{out} Front Panel Display Readback	127.807A $I_{out} - 218mA$	_____A _____mA	+128.193A $I_{out} + 218mA$	24mA 24mA
PARD (Ripple and Noise) RMS	0	_____mA	45mA	0.23mA
Load Effect	$I_{out} - 15mA$	_____mA	$I_{out} + 15mA$	138mA
Source Effect	$I_{out} - 15mA$	_____mA	$I_{out} + 15mA$	138mA
*Enter your test results in this column.				

Troubleshooting

WARNING

Shock Hazard: Most of the procedures in this chapter must be performed with power applied and protective covers removed. These procedures should be done only by trained service personnel aware of the hazard from electrical shock.

CAUTION

This instrument uses components that can be damaged or suffer serious performance degradation due to ESD (electrostatic discharge). Observe standard antistatic precautions to avoid damage to the components (see Chapter 1).

Introduction

Localizing the Problem

This chapter provides troubleshooting and repair information for the power supply. Before beginning troubleshooting procedures, make certain the problem is in the power supply and not with an associated circuit, the GPIB controller (for GPIB system power supplies), or ac input line. Without removing the covers, you can use the Verification tests in Chapter 2 to determine if the power supply is operating normally.

Chapter Organization

The information in this chapter is organized as follows:

Topic	Information Given
Test Equipment Required	Equipment required for completing all the tests in this chapter.
Troubleshooting Procedures	<p>A series of flow charts for systematic location of defective boards, circuits, and components. An explanation of the error codes and messages generated during the power-on selftest. Signature analysis techniques for troubleshooting the digital circuits on the front panel, primary GPIB, and secondary interface circuits. Specific paragraphs for:</p> <ul style="list-style-type: none"> • Checking the bias and reference supplies. • Troubleshooting the CV/CC status annunciators. • Troubleshooting the A3 FET board.
Post-Repair Adjustments	Calibration and EEPROM initialization procedures required after the replacement of certain critical components.
Disassembly Procedures	Gaining access to and/or replacing components.

Test Equipment Required

Table 3-1. Test Equipment Required

Equipment	Purpose	Recommended Model
Logic Probe	To check states of data lines.	Agilent 545A
Test Clips	To gain access to IC pins.	AP Products No. LTC
Ammeter/Current Shunt	To measure output current.	Agilent 6680A & 6681A: Burster 1280 Agilent 6682A, 6683A & 6684A: Guildline 9230/300
Oscilloscope	To check waveforms and signal levels.	Agilent 54504A
Signature Analyzer	To troubleshoot most of the primary and secondary interface circuits.	Agilent 5005A/B
GPIB Controller	To communicate with power supply via the GPIB (for system units).	Agilent BASIC series
DC Voltmeter	To measure output voltage and current, bias and references.	Agilent 3458A

Troubleshooting Procedures

Power-On Selftest

Description

The procedures in the troubleshooting charts make use of the power-on selftest. The power-on selftest tests the front panel, GPIB interface (for GPIB system power supplies), and secondary interface circuits. If the power supply fails the selftest, the output remains disabled (turned off) and the front panel normally displays an error code or message (see Table 3-2). The message is displayed indefinitely and the power supply will not accept GPIB or front panel commands.

Disabling The Power-On Selftest

In order to perform troubleshooting procedures that require programming of the power supply, you must disable the power-on self test. Do this as follows:

1. Turn off the power supply.
2. Hold down the **7** key and turn on the supply.
3. Continue holding down the **7** for 2 seconds and wait until the **PWR ON INIT** indicator goes off.
4. The power supply is now on without executing power-on selftest.

Using the *TST? Query (GPIB Systems Supplies Only)

You can get the power supply to execute a partial selftest by sending it the GPIB ***TST?** query command. Table 3-2 shows the tests that are performed in response to this command. These tests do not interfere with normal operation or cause the output to change. The command returns a value of "0" if all tests pass. Otherwise, the command returns the error code of the first test that failed. No error codes are displayed on the front panel and the power supply will attempt to continue normal operation.

Table 3-2. Selftest Error Codes/Messages

Code and/or Message	Description	Probable Cause Selftest Error Codes/Messages
E1 FP RAM	Front panel RAM test failed (power-on).	Microprocessor AIU3
E2 FP ROM	Front panel ROM test failed (power-on and *TST?).	ROM AIU4 or address latches AIU8
E3 EE CHKSM	Front panel EEPROM checksum test failed (power-on and *TST?).	Possibly due to power loss during a write operation. See Checksum Errors in Chapter 3 of Operating Manual. If power loss is not the problem, EEPROM AIU6 could be defective. (If you replace AIU6, the power supply must be reinitialized and calibrated.)
E4 PRI XRAM	Primary interface external RAM test failed (power-on).	RAM A2U108
E5 PRI IRAM	Primary interface internal RAM test failed (power-on).	Microprocessor A2U114
E6 PRI ROM	Primary interface ROM test failed (power-on and *TST?).	ROM A2U106
E7 GPIB	GPIB interface test failed (power-on).	Talker/listener A2U117
E8 SEC RAM	Secondary interface RAM test failed (power-on).	Microprocessor AI0U506
E9 SEC ROM	Secondary interface ROM test failed (power-on and *TST?).	Microprocessor AI0U506
E10 SEC 5V	Secondary interface 5 volt readback test failed (power-on and *TST?).	Comparators AI0U516, AI0U517 readback DAC AI0U512/U515, or secondary bias supply (5Vs A4U304)
E11 TEMP	Ambient temperature readback test failed (power-on and *TST?).	Thermistor AI0RT500 or comparator AI0U517
E12 DACS	CV or CC DAC tests failed (power-on).	CV DAC AI0U510/U513 or CC DAC AI0U511/U514 (see Figure 3-7).
NOTE: The following error messages can appear due to a failure occurring either while the power supply is operating or during selftest.		
SERIAL TIMOUT	Serial data line failure on A2 board.	See Figure 3-10 (system) or Figure 3-11 (bench).
SERIAL DOWN	Serial data line failure on A2 board.	See Figure 3-10 (system) or Figure 3-11 (bench).
UART PARITY	UART failed.	UART A2U112
UART FRAMING	UART failed.	UART A2U112
UART OVERRUN	UART failed.	UART A2U112
SBUF OVERRUN	Serial buffer failure UART.	UART A2U112 defective or GPIB board is in SA mode
SBUF FULL	Serial buffer failure.	UART A2U112 defective or GPIB board is in SA mode
EE WRITE ERR	EEPROM write failure.	EEPROM AIU6 defective or calibration error
SECONDARY DN	Serial data line failure on Main board.	See Figure 3-12.

Troubleshooting Charts

Figure 3-1 gives overall troubleshooting procedures to isolate the fault to a circuit board or particular circuit (see Figure 3-20 for the location of the circuit boards). These procedures include the use of power-on selftest (Table 3-2) and signature analysis techniques (Table 3-5 through Table 3-7). Some results of Figure 3-1 lead to more detailed troubleshooting charts that guide you to specific components. The troubleshooting charts are organized as follows:

Chart	Trouble or Circuit
Figure 3-1	Overall procedure checks selftest errors, calibration errors, ac input circuit, fan, readback circuits, A10 Control Board, GPIB cable, digital port, serial link, rotary controls, current amplifier.
Figure 3-2	No display (from Figure 3-1).
Figure 3-3	OV circuit not firing (from Figure 3-1).
Figure 3-4	OV circuit is on at turn on (from Figure 3-1).
Figure 3-5	Output level is held low (from Figure 3-1).
Figure 3-6	Output level is held high (from Figure 3-1).
Figure 3-7	DAC circuits (from Figure 3-1).
Figure 3-8	DAC test waveforms.
Figure 3-9	CV and CC DAC and amplifiers (from Figure 3-1).
Figure 3-10	Serial Down circuit (from Figure 3-1).
Figure 3-11	Secondary interface circuit (from Figure 3-1).
Figure 3-12	Slow downprogramming circuit (from Figure 3-1).

Troubleshooting Test Points

The troubleshooting charts reference test points listed in Table 6-3 of Chapter 6. Test points are identified by an encircled number (such as ⑤ in schematic diagrams and component location drawings, also in Chapter 6).

Bias and Reference Supplies

Many of the following troubleshooting procedures begin by checking the bias and/or reference voltages. Table 6-3 lists the test points for these voltages and gives the correct reading for each. The circuit board component location diagrams identify these points on each board.

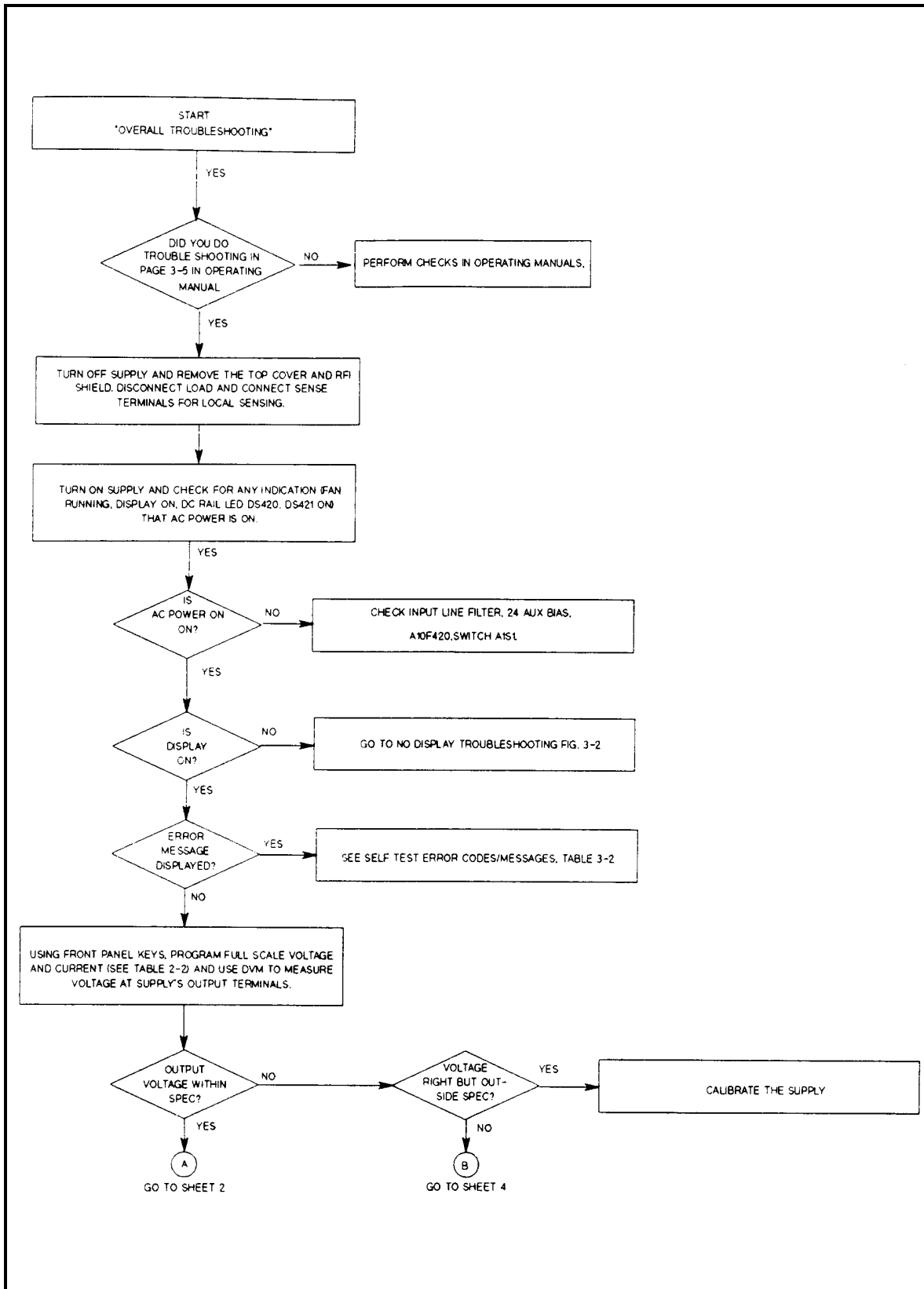

Figure 3-1. Overall Troubleshooting (Sheet 1 of 4)

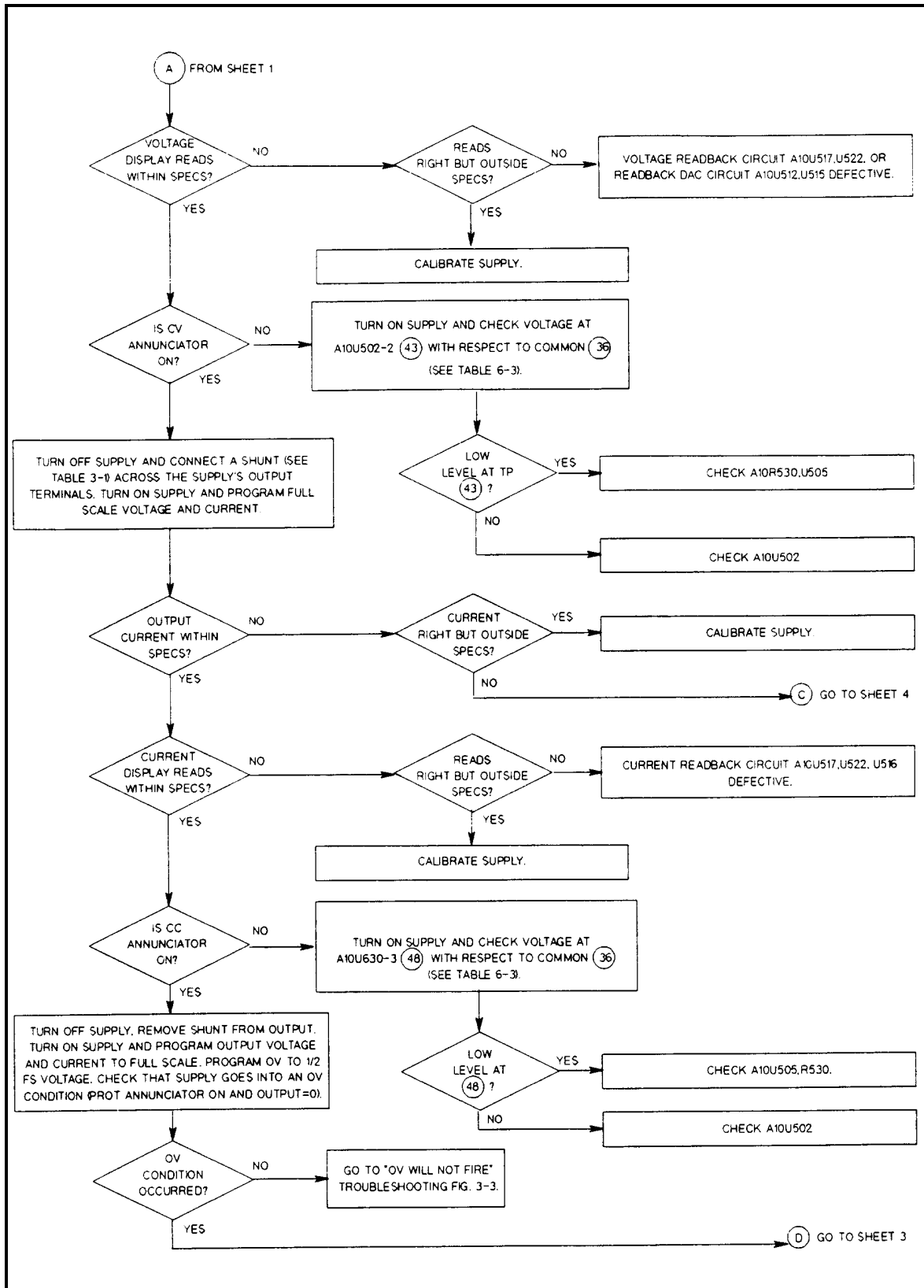

Figure 3-1. Overall Troubleshooting (Sheet 2 of 4)

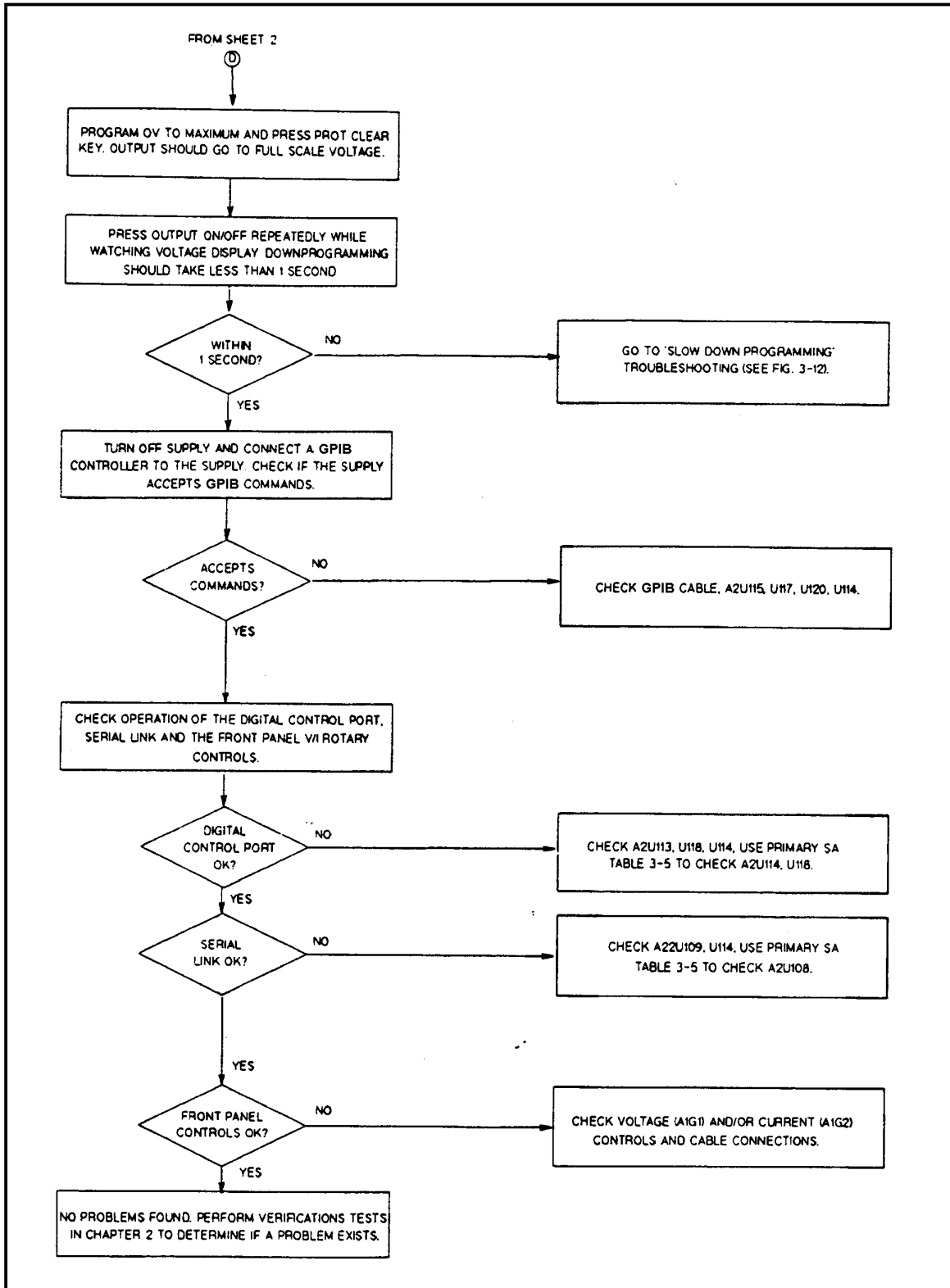

Figure 3-1. Overall Troubleshooting (Sheet 3 of 4)

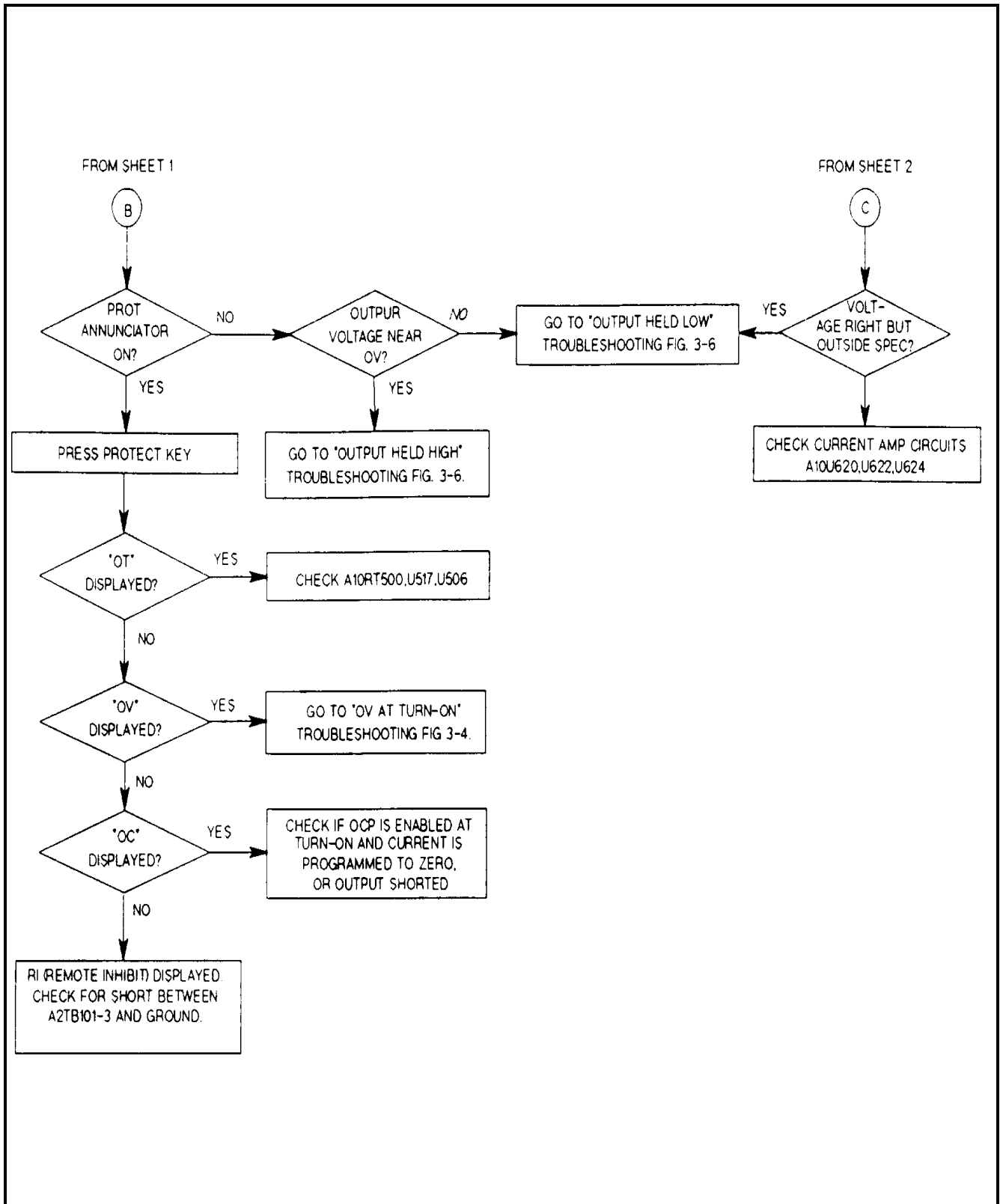

Figure 3-1. Overall Troubleshooting (Sheet 4 of 4)

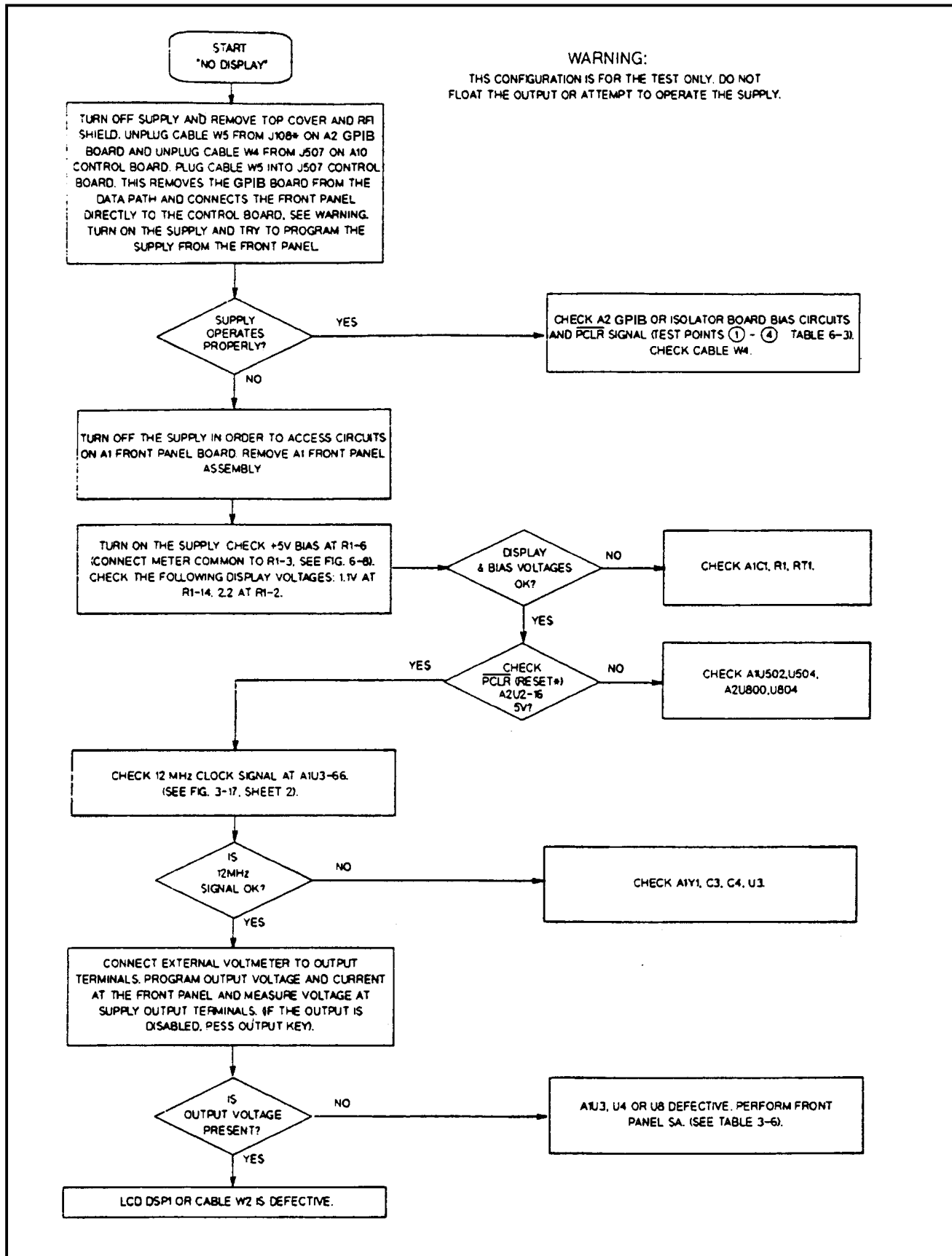

Figure 3-2. No Display Troubleshooting

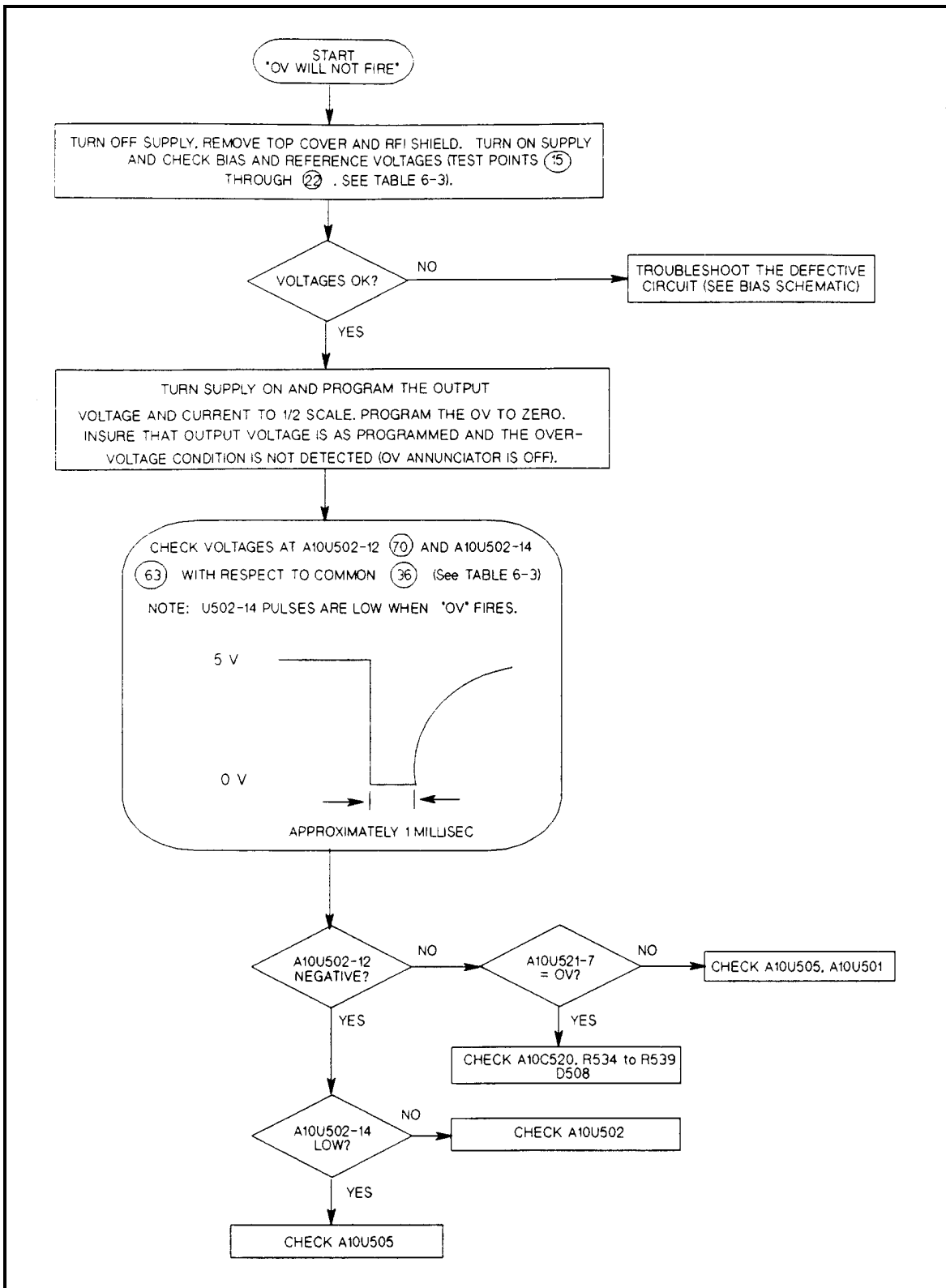

Figure 3-3. OV Will Not Fire Troubleshooting

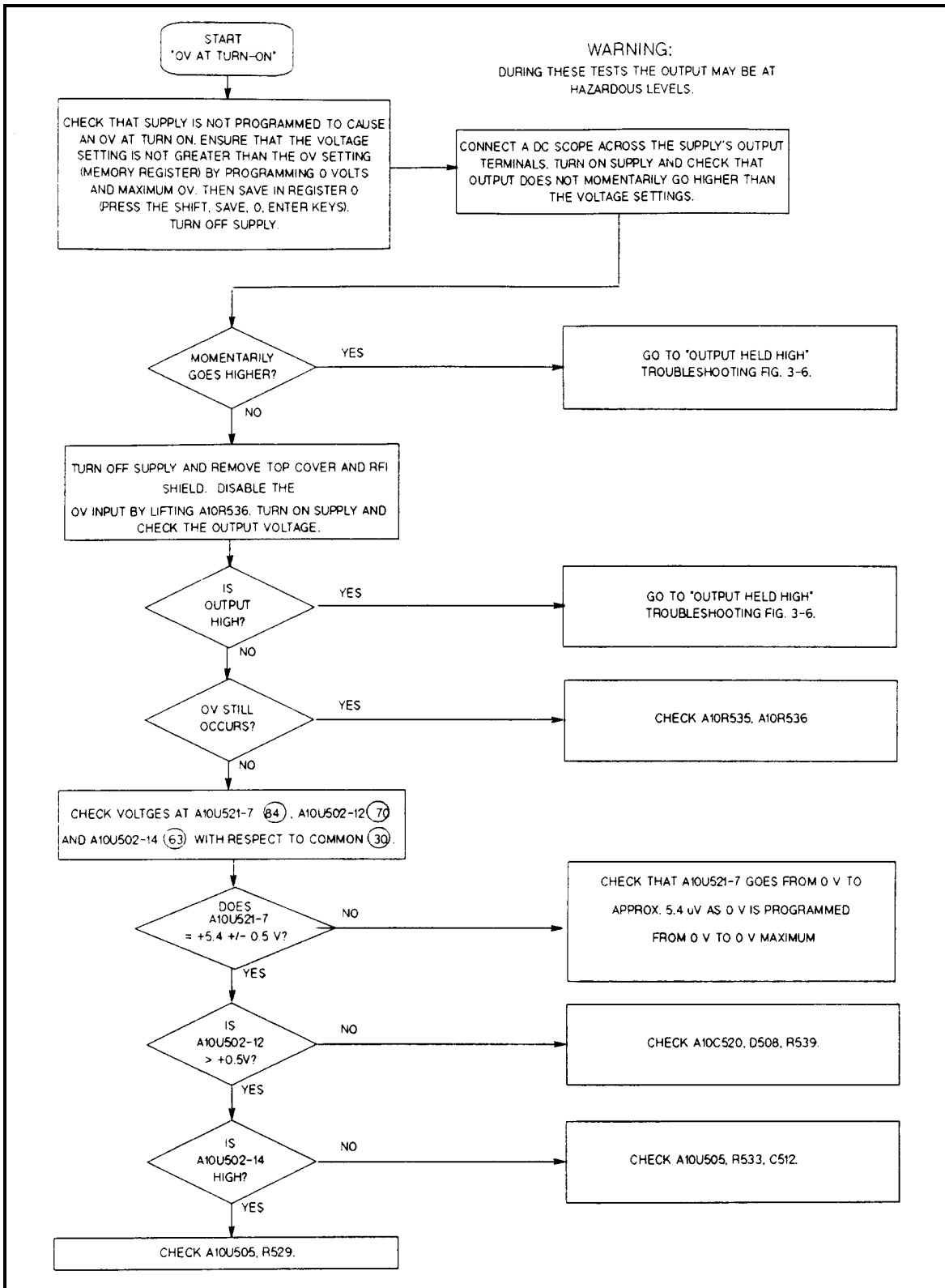

Figure 3-4. OV At Turn-On Troubleshooting

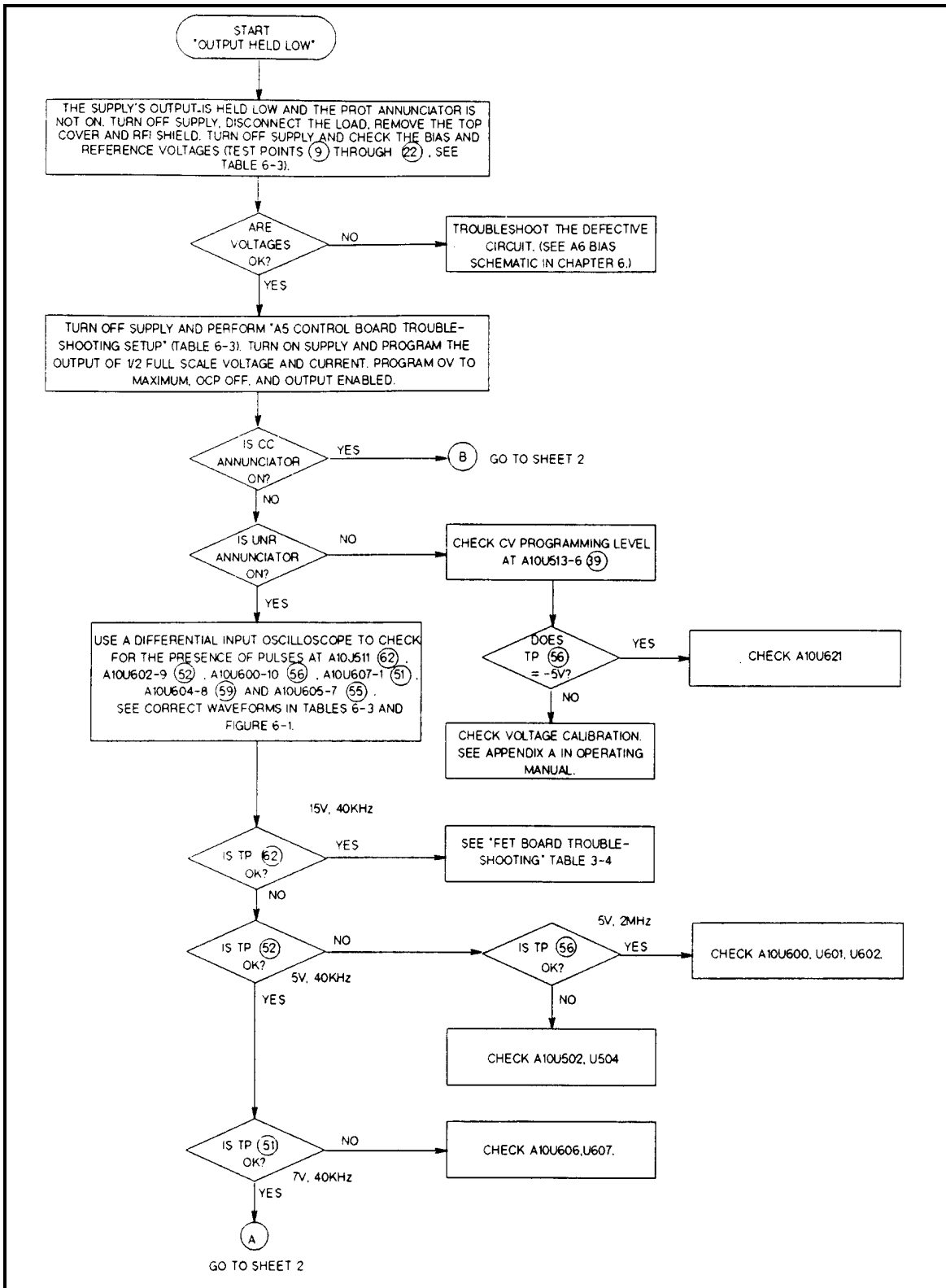

Figure 3-5. Output Held Low Troubleshooting (Sheet 1 of 2)

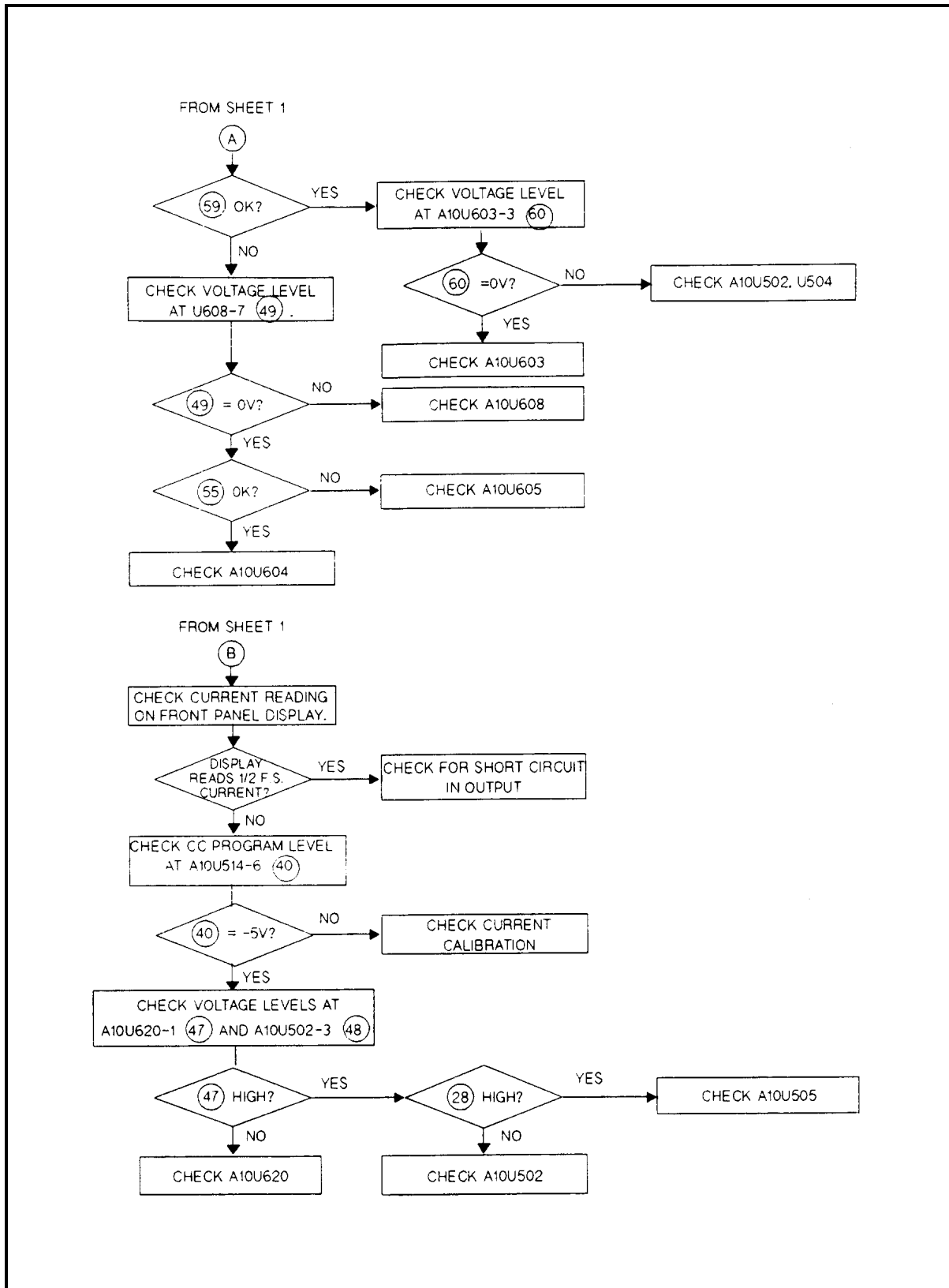

Figure 3-5. Output Held Low Troubleshooting (Sheet 2 of 2)

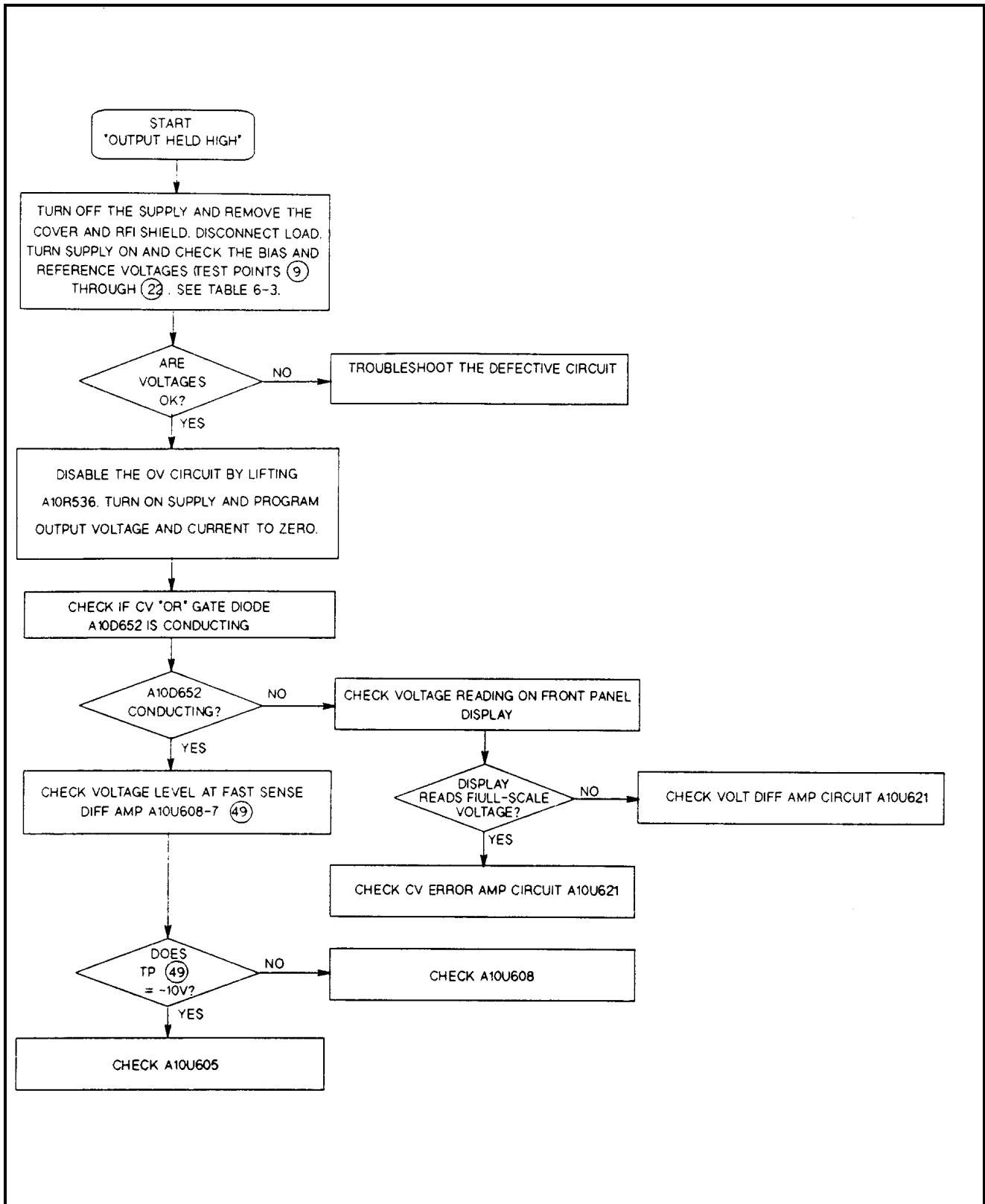

Figure 3-6. Output Held High Troubleshooting

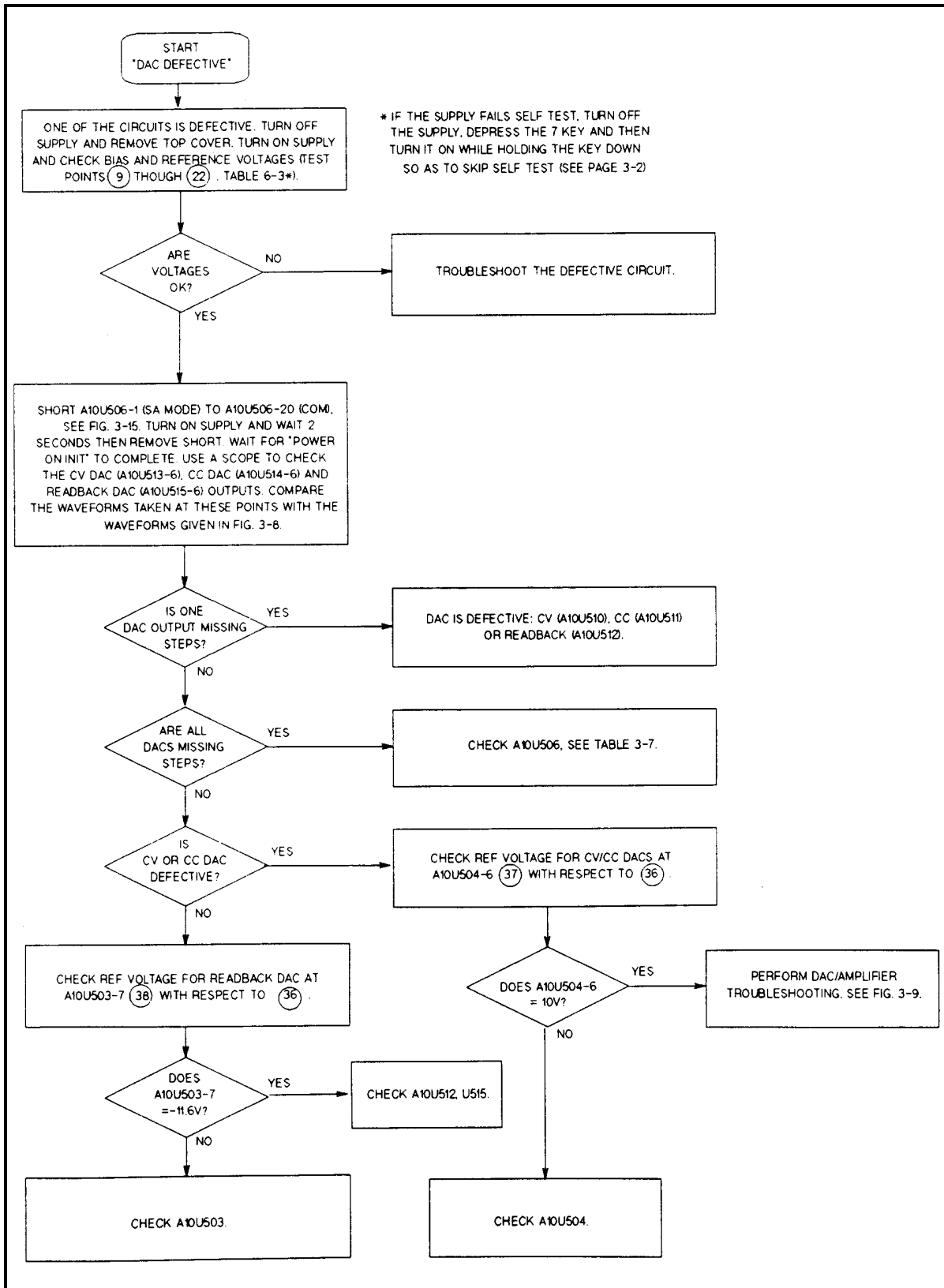
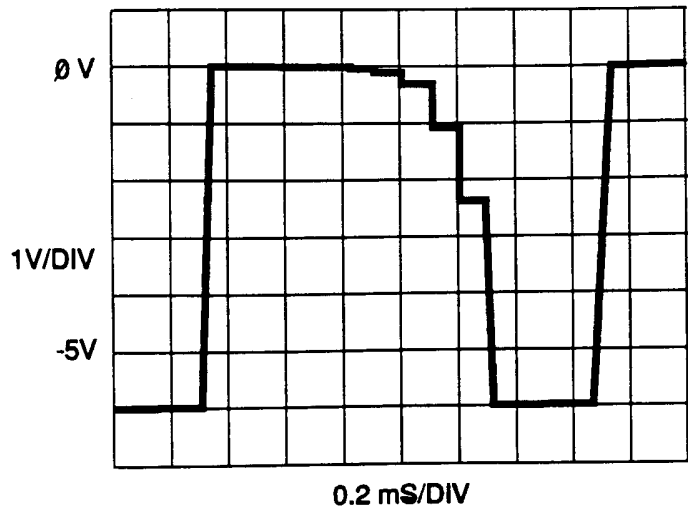
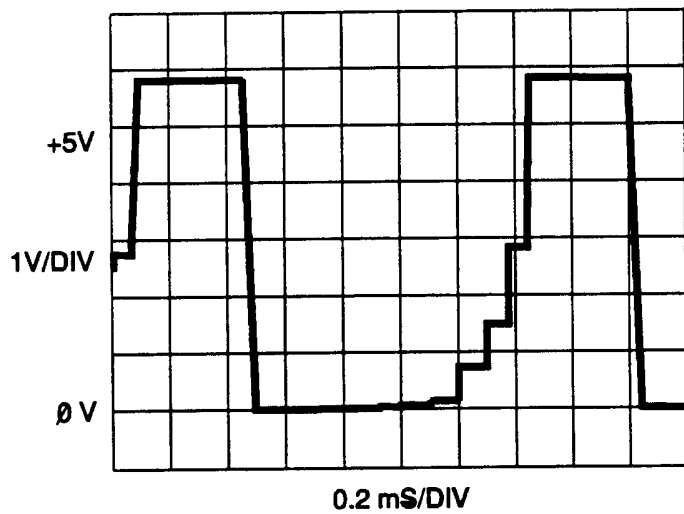

Figure 3-7. DAC Circuits Troubleshooting



A. CV DAC (U508-6) AND
CC DAC (U510-6) OUTPUTS



B. READBACK DAC (U512-6) OUTPUT

Figure 3-8. DAC Test Waveforms

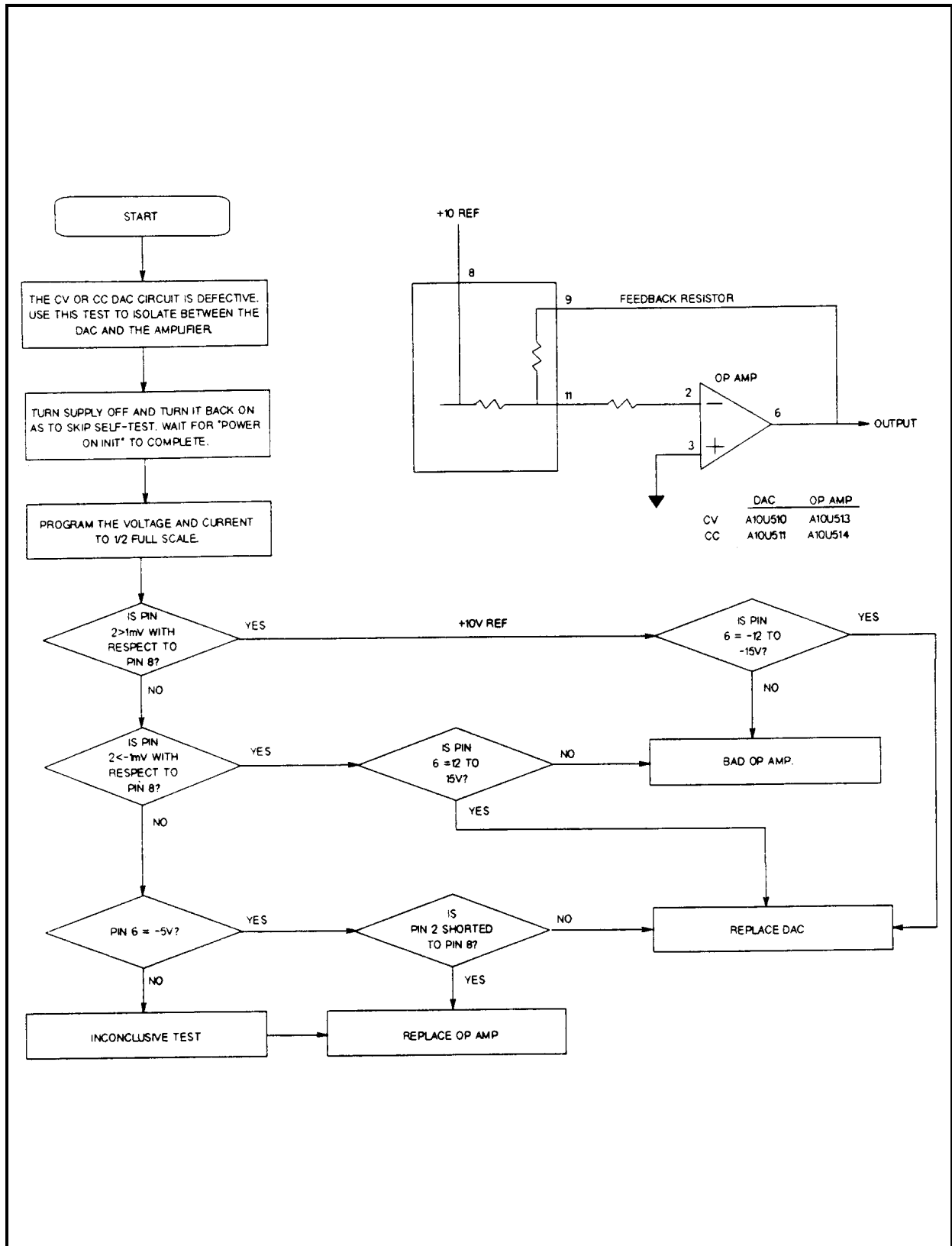

Figure 3-9. CV/CC DAC and Amplifier Circuit Troubleshooting

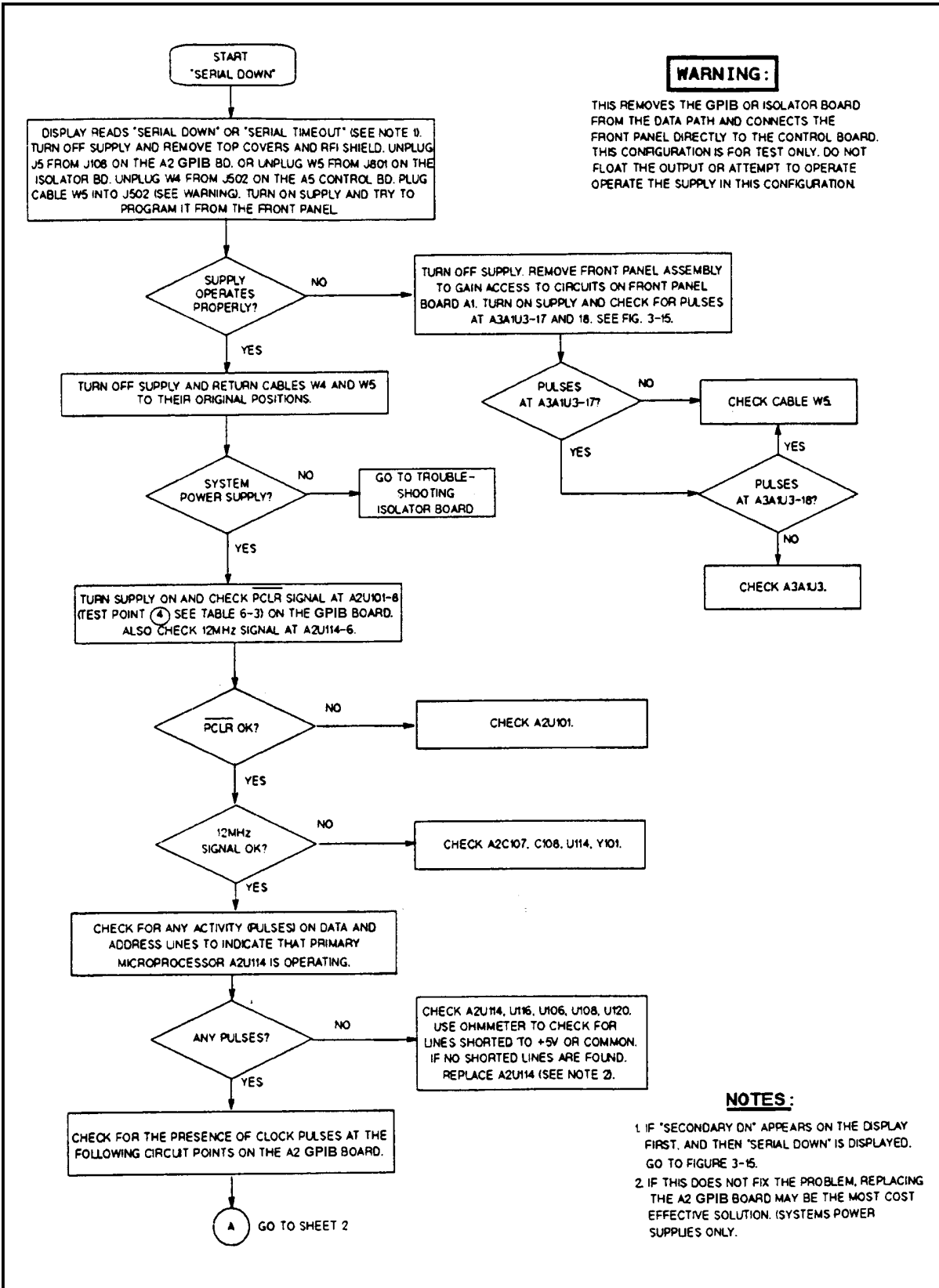

Figure 3-10. Serial Down Troubleshooting (Sheet 1 of 2)

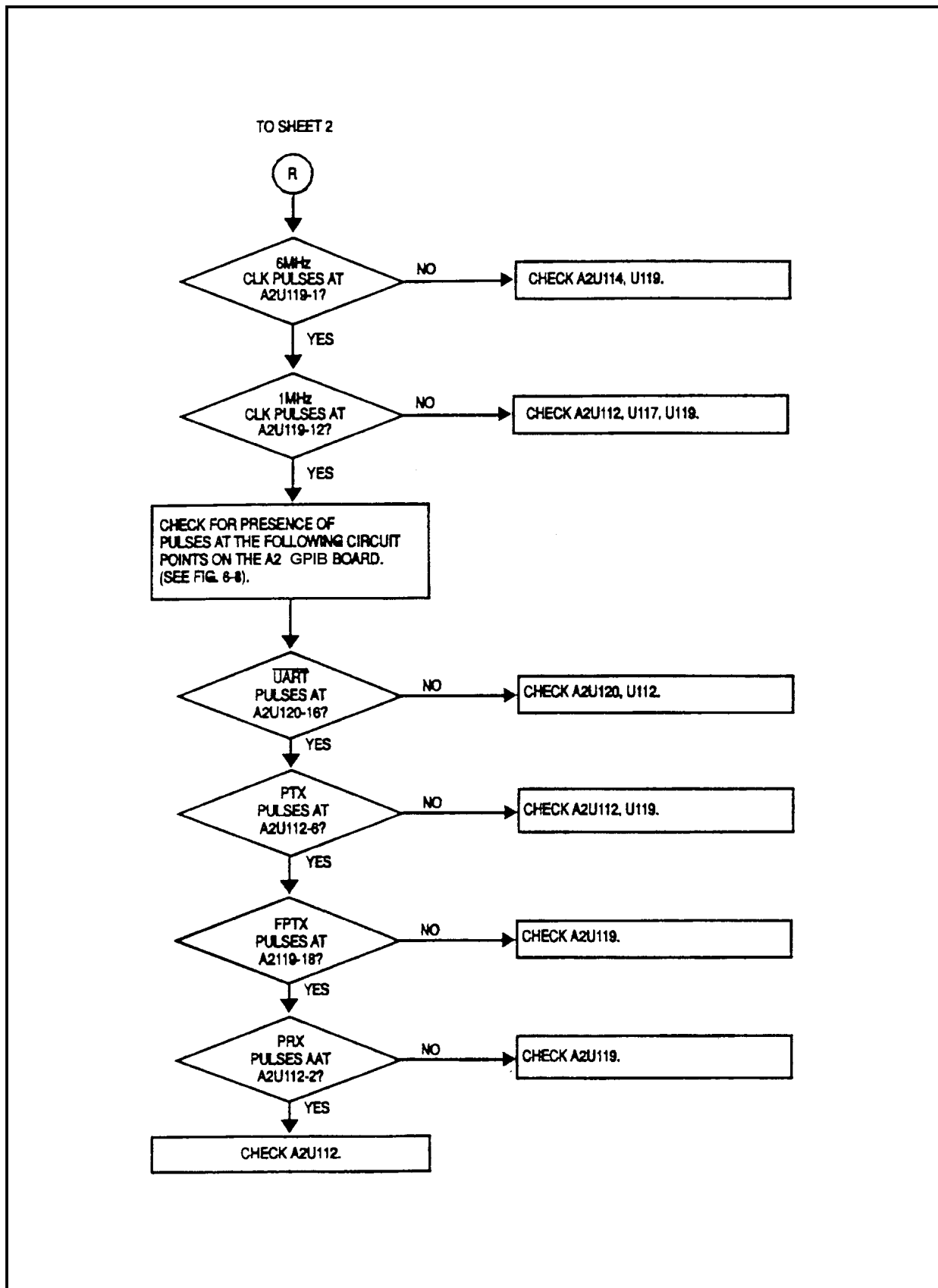

Figure 3-10. Serial Down Troubleshooting (Sheet 2 of 2)

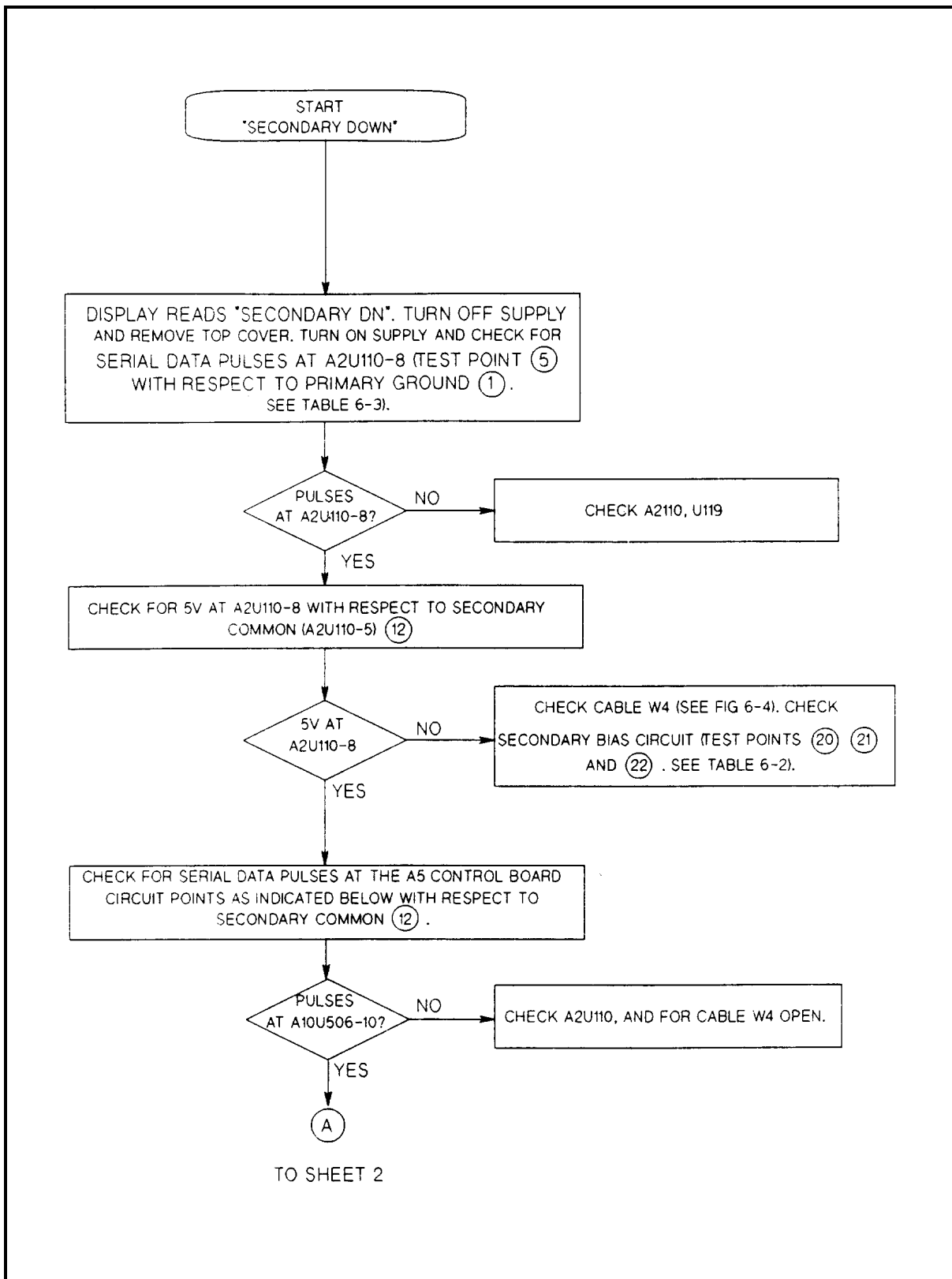

Figure 3-11. Secondary Interface Down (Sheet 1 of 2)

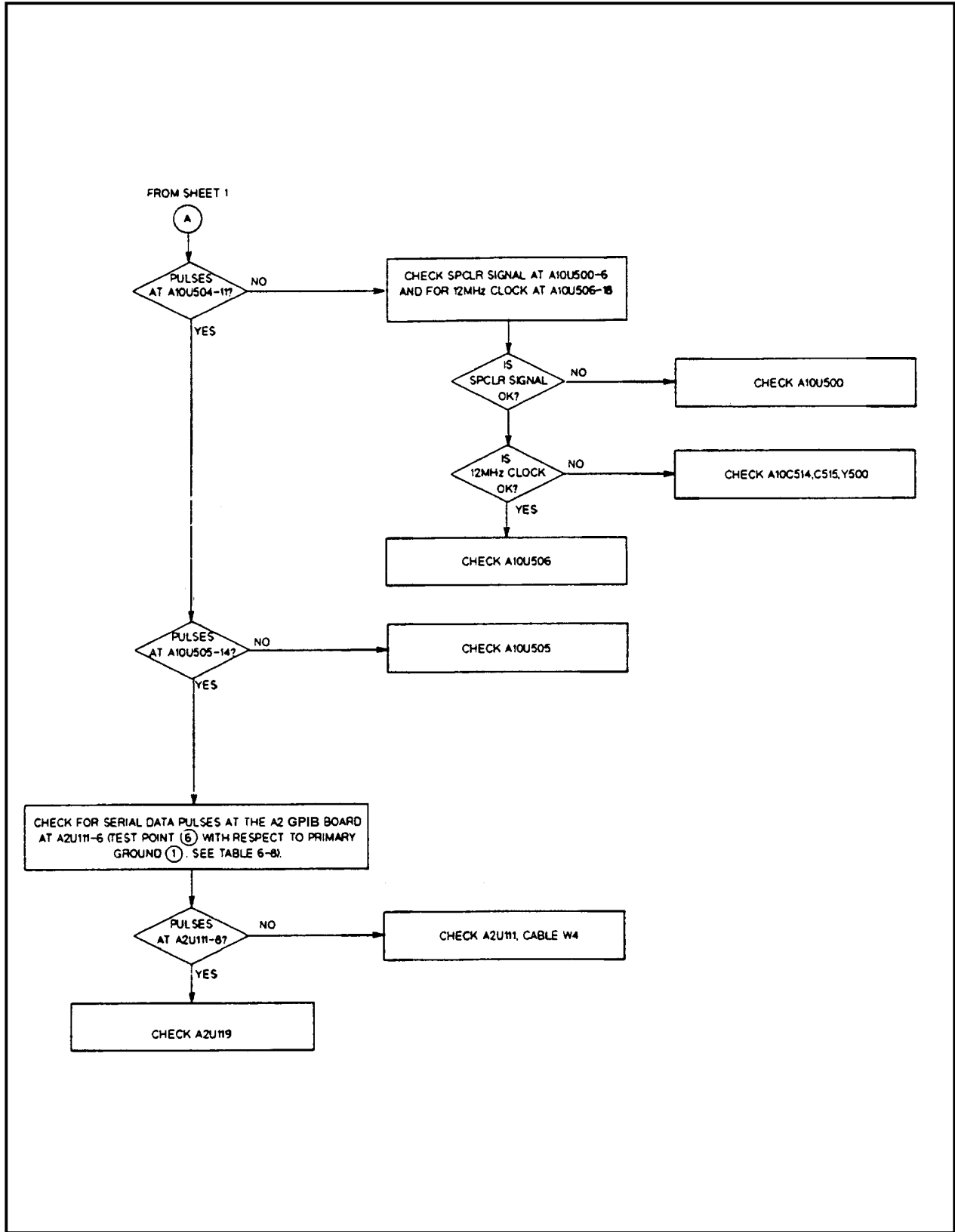

Figure 3-11. Secondary Interface Down (Sheet 2 of 2)

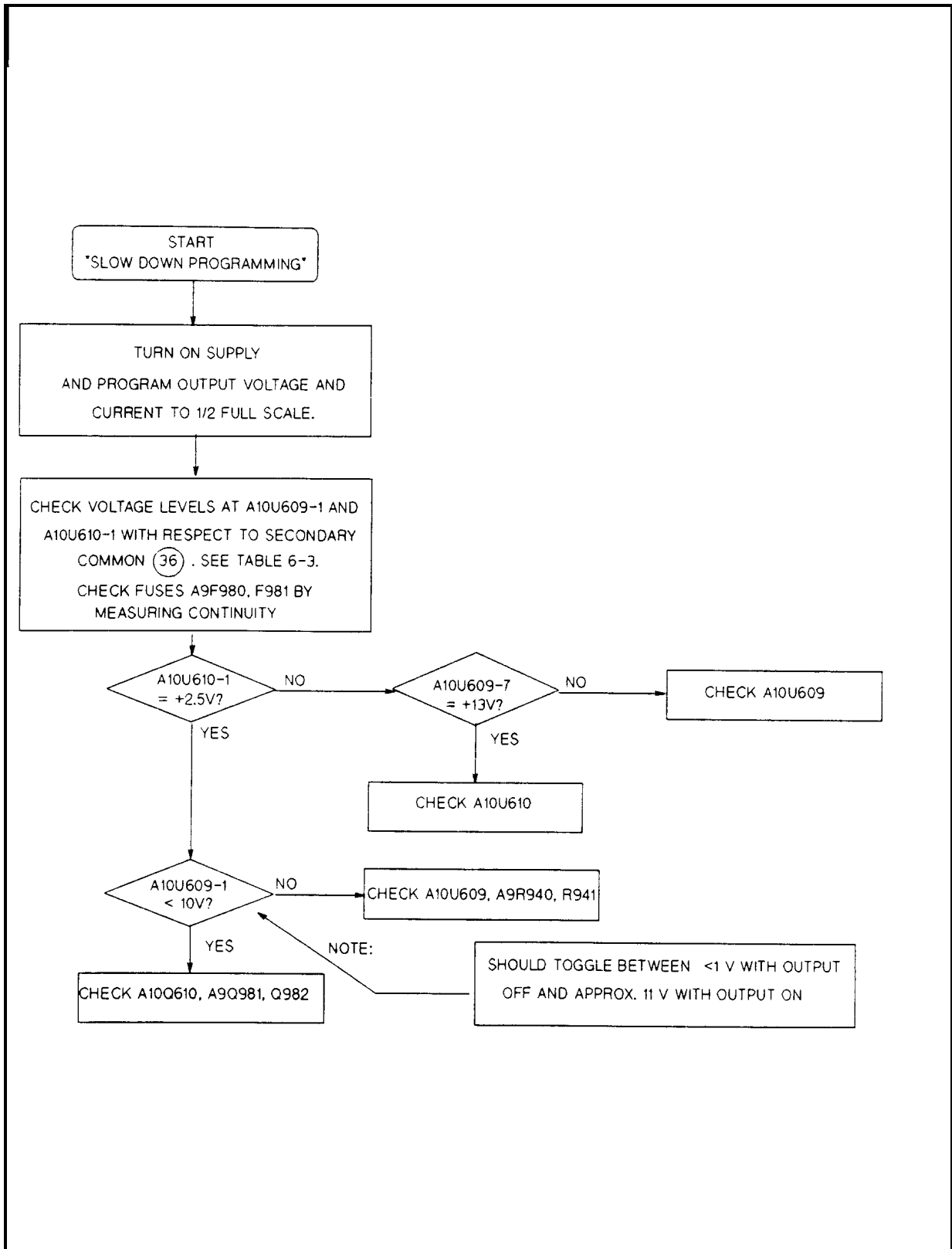

Figure 3-12. Slow Downprogramming Troubleshooting

CV/CC Status Annunciators Troubleshooting

When troubleshooting the CV/CC status annunciators or status readback circuits, first measure the voltage drop across the gating diodes, which are A10D651 for the CC circuit and A10D652 for the CV circuit (see A10, Sheet 2). A conducting diode indicates an active (ON) control circuit. This forward drop is applied to the input of the associated status comparator (A10U502) and drives the output low. The low signal indicates an active status which is sent to the secondary microprocessor A10U506 via Programmed GAL A10U505 (see schematic Sheet 1). The front panel CV annunciator lights when the CV mode is active (CV is low) and the CC annunciator lights when the CC mode is active (CC is low). If neither is active, the UNREGULATED (Unr) annunciator comes on.

A3 FET Board Troubleshooting

Because test points on the FET board are not accessible when the board is installed, troubleshooting must be performed with the board removed from the power supply. Both static (power removed) and dynamic (power applied) troubleshooting procedures are provided. The location of different test points are shown by encircled numbers on the A3 FET Board schematic and component location diagrams (see Chapter 6). There are two isolated FET bridge assemblies (see schematic in Fig. 6-10 sheets 1 and 2). Test each FET bridge individually.

Note If any power FET (Q201-204, Q301-304, Q211, Q311, Q222, Q322, Q233, Q333, Q244, Q344) is defective, you must replace all eight with a matched set.

Table 3-4. FET Troubleshooting Chart

Procedure	Result
Static Troubleshooting	
1. Turn the power supply off and remove the A3 FET board with its heatsink assembly attached (see "Disassembly Procedures").	
2. Measure the resistance between the + Rail (E202 & E302) and the - Rail (E201 & E301).	$\geq 20M\Omega$.
3. Measure the resistance between the gate of each FET (Q201-204, Q211, Q222, Q233, Q244, and Q301-304, Q311, Q322, Q333, and Q344) and common (-Rail).	$>15K\Omega$.
4. Measure the resistance across capacitor C201 & C301.	$\approx 150\Omega$.
5. Measure the resistance across the 15V bias input (E206 to E207 and E306 to E307).	$\approx 1K\Omega$ in the forward direction and 490Ω in the reverse direction.
<i>Continue with Dynamic Troubleshooting on the next page</i>	

Table 3-4. FET Troubleshooting Chart (continued)

Procedure	Result
Dynamic Troubleshooting	
1. Turn off the power supply and remove the A3 FET Board with its heat sink assembly.	See "Disassembly Procedures"
2. Short the collectors of Q251 and Q253 or Q351 and Q353 by connecting the collector (case) of each transistor to common (E507) .	
3. Connect waveform generator to J200-1 and J200-2.	
4. Set generator to produce a 20 kHz, 20V p-p triangular waveform	See Figure 3-14A.
5. Connect 15V from an external supply to E206 or E306 (positive) and E207 or E307 (common). Note: All of the following measurements are taken with respect to E207/E307 common, test point (26) on A3 FET Board schematic diagram	
6. Check bias voltage at U203-1/U303-1 (27) .	+5V
7. While adjusting the external 15V supply input, check the bias trip point at U204-1/U304-1 (28) .	Voltage goes from low (0V) to high (5V) at an input of approximately 12V; and from high to low at an input of approximately 13V.
8. Set external supply input to + 15V and check drive 1 waveform at U201-10/U301-10 (29) and drive 2 waveform at U201-12/U301-12 (30) .	See Figure 3-14B.
9. Check that pulses are present at U201-1 (31) , U201-7/U301-7 (32) and U302-1, U202-1 (33) , U202-7/U302-7 (34) .	See Figure 3-14C.
10. Pulses should be present on both sides of inductors L201-204 or L301-304 and L213-216 or L313-316 as follows: Check the pulses on the driver transistor side (Q251-Q254/Q351-Q354) of each inductor. Check the pulses on the FET regulator side (Q201-Q204, Q301-Q304, Q211, Q311, Q222, Q322, Q233, Q333 and Q244, Q344) of each inductor. If the waveforms do not have the fast step as shown in Figure 3-14, then the associated FET gate input has an open circuit.	See Figure 3-14D. See Figure 3-14E.
11. Measure the VREF voltage at U205-2 (35) .	≈ 1.7V
Check the peak current limit by connecting a 68KΩ resistor from +5V (U201-9) to U205-3 or U304-5.	All pulses turn off.

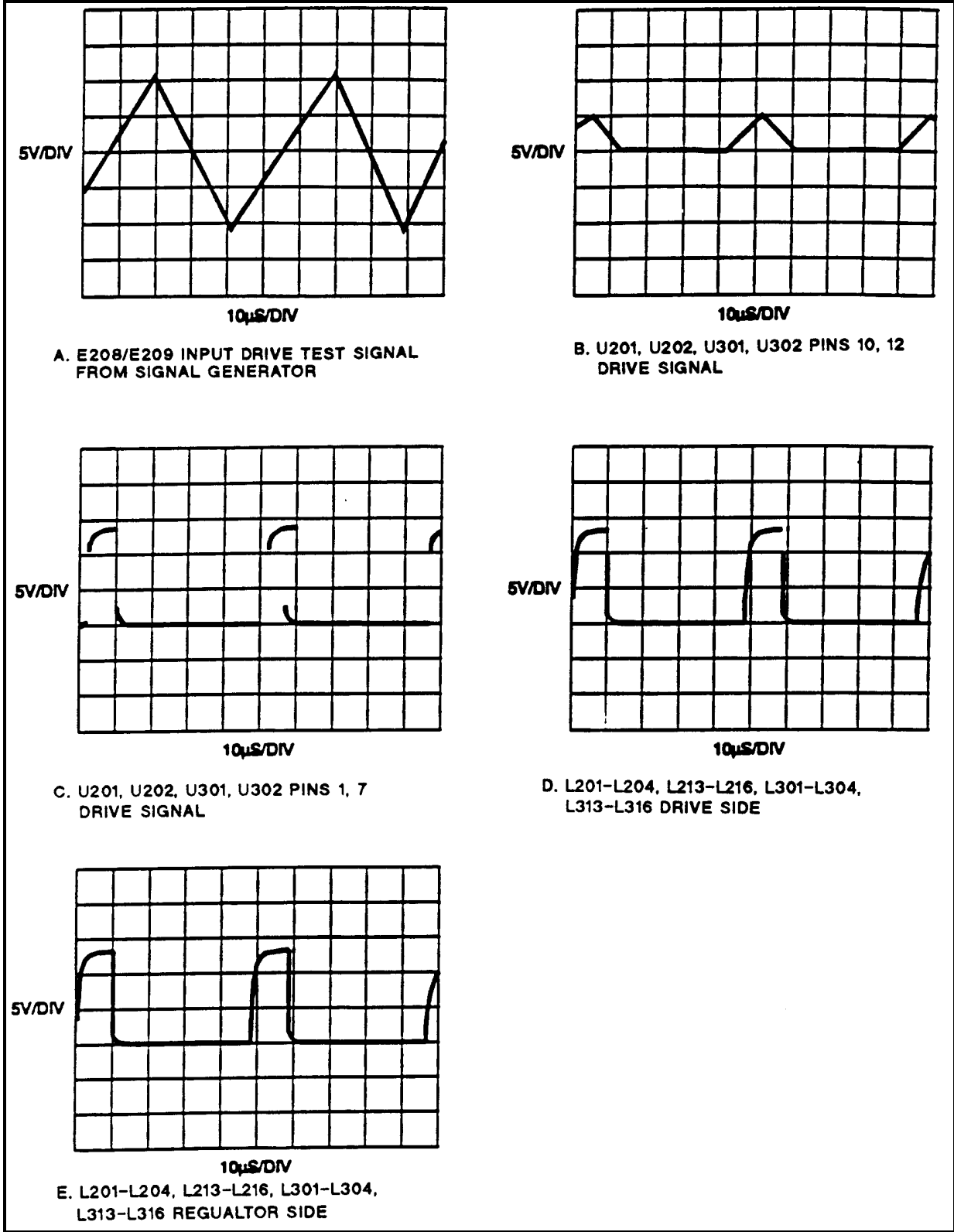

Figure 3-13. A3 FET Board Test Waveforms

Signature Analysis

Introduction

The easiest and most efficient method of troubleshooting microprocessor-based instruments is with signature analysis (SA). This technique is similar to signal tracing with an oscilloscope in linear circuits. Part of the microprocessor memory is dedicated to SA, and a known bit stream is generated to stimulate as many nodes as possible within a circuit. Because it is virtually impossible to analyze a bit stream with an oscilloscope, a signature analyzer is used to compress the bit stream into a four-character signature. By comparing the signatures of the IC under test to the correct signature for each node, you can isolate faults to one or two components .

The following general rules apply to signature analysis testing:

1. Be sure to use the correct test setup connections for the specific test.
2. When examining an IC, note the correct signatures for Vcc (+5V) and for common. If an incorrect signature matches either one, it probably indicates a short to that part of the circuit.
3. If two IC pins have identical signatures, they are probably shorted.
4. If two IC signatures are similar, it is only a coincidence.
5. If an input pin of an IC has an incorrect signal but the signal source (output of the previous IC) is correct, then look for an open printed circuit track or soldering problems.
6. If the output signature of an IC is incorrect, it could be caused by that IC. However, it could also be caused by a short at another component that is connected to that output.

Firmware Revisions

Each signature analysis table in this chapter shows the power supply firmware revision for which the table is valid. If needed, for a Bench Supply you can confirm the firmware revision of your power supply by checking the label on the Front panel ROM, AIU3, and on the Secondary microprocessor, A5U504. You can obtain the revisions on a Systems Supply with the GPIB *IDN? query command. The following sample Agilent BASIC program does this:

```
10 ALLOCATE L$(52)
20 OUTPUT 705;"*IDN?"
30 ENTER 705;L$
40 DISP L$
50 END
```

For a typical Model 6681A, the controller will return a string with four comma-separated fields, as follows:

```
"Agilent Technologies ,6681A,O,fA.01.05sA.01.04pA.01.02"
```

The first three fields in the string are the manufacturer, model number and 0. The last field gives the firmware information as follows:

```
f= front panel firmware revision (A.01.05).
s= secondary interface firmware revision (A.01.04).
p= primary interface firmware revision (A.01.02).
```

Note

The firmware revisions numbers shown here may not match the firmware revision of your instrument. Firmware revision numbers are subject to change whenever the firmware is updated.

Test Headers

The power supply has two test headers as shown in Figure 3-15, each with a jumper that can be moved to different positions for SA testing and for other functions. To gain access to the headers, remove the power supply top cover.

Pins	Description
Primary Interface Test Connector A2J106 (Systems Supplies Only)	
7 and 8 (FLT/INH)	Normal operating (and storage) position. DIG CNTL port** is configured for fault indicator (FLT) output and remote inhibit (RI) input .
1 and 2 (SA Mode)	Install jumper here for SA mode.
3 and 4 (DIG I/O)	Install jumper here to configure DIG CNTL port** for digital I/O operation .
5 and 6 (RELAY LINK)	Install jumper here to configure DIG CNTL port** for control of external relay accessories. ** See Appendix D in power supply Operating Manual for information about the digital control port.
Front Panel Test Connector A1J3	
7 and 8 (NORM)	Normal operating (and storage) position of jumper.
1 and 2 (SA Mode)	Install jumper here for SA mode.
3 and 4 (INHIBIT CAL)	Install jumper here to disable calibration commands and prohibit calibration.
5 and 6 (FACTORY PRESET CAL)	Install jumper here to restore original factory calibration constants.

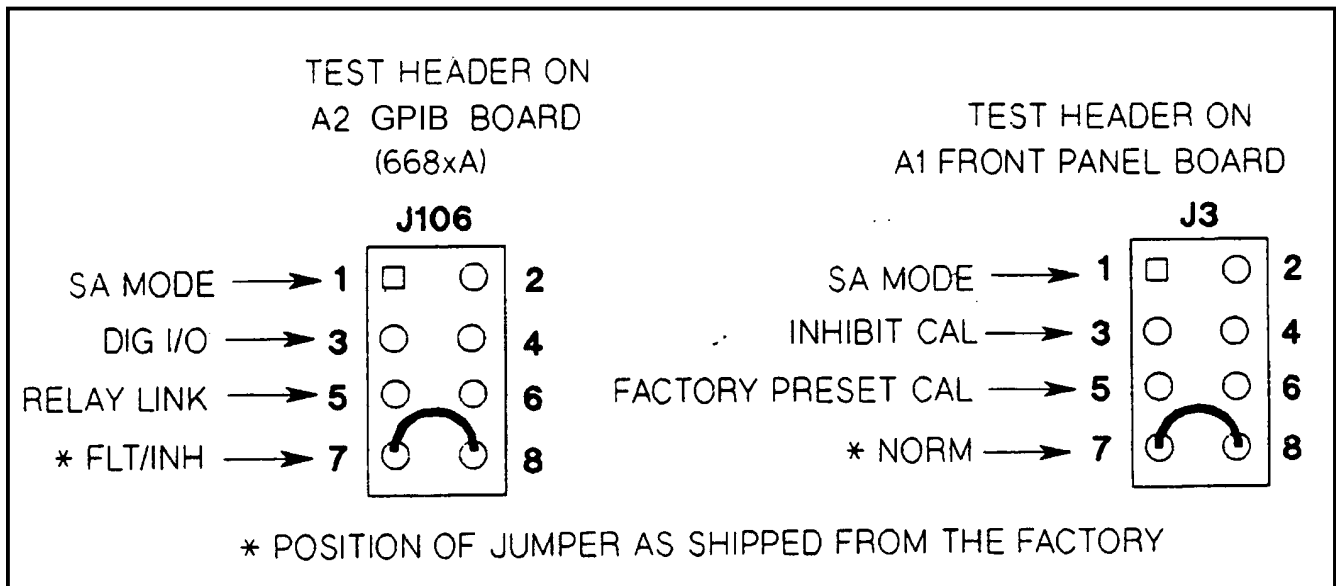

Figure 3-14. Test Header Jumper Positions

Table 3-5. Primary Interface SA Test

<p>Description: These signatures check some primary interface circuits on the Systems Supply A2 GPIB Board. Valid A2U106 ROM Firmware Revision: A.01.06 Test Setup: See Figure 3-17.</p>
1. Turn off the power supply and remove the top cover.
2. Connect SA jumper of connector J106 on A2 GPIB Board (see Figure 3-15).
3. Connect signature analyzer CLOCK, START, STOP, and GROUND inputs as show in Figure 3-16 .
<p>4. Turn on the power supply and use the signature analyzer probe to take the following signatures:</p> <p>Power: 5V = 9FFP Serial Link: A2U109-3 = 0104 Microprocessor: A2U114-24 = 9FFP A2U114-25 = UF39 Digital Control Interface: A2U118-1 = 9AF1 A2U118-9 = 40A5 A2U118-10 = 1029 A2U118-15 = 0010 A2U118-16 = 040A Gated Array Logic: A2U119-2 = 0A55 A2U119-5 = 0040 A2U119-15 = 0040</p>
5. After completing the tests, be sure to return the J106 jumper to its original position.





Signature Analyzer Input	Edge Setting	A2 Board Connection	A1A1 Front Panel Board Connection	A10 Board Connection
CLOCK		J106-5	J2-9	U504-32
START		J106-6	J2-11	U502-7
STOP		J106-6	J2-11	U502-7
GROUND		J106-4	J2-8	U502-10

Figure 3-15. Signature Analysis Signal Inputs

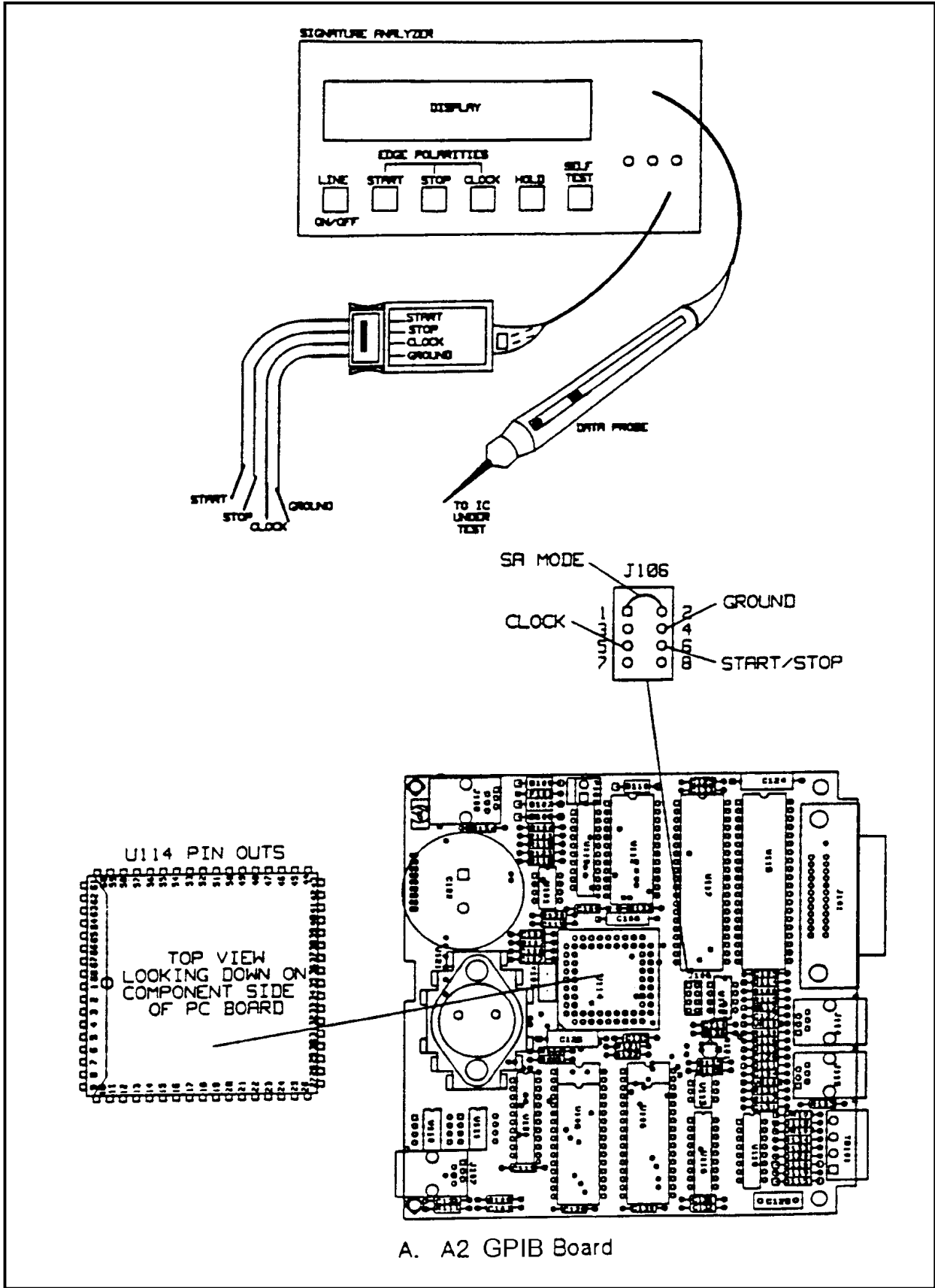

Figure 3-16. Signature Analysis Connections, (Sheet 1 of 2)

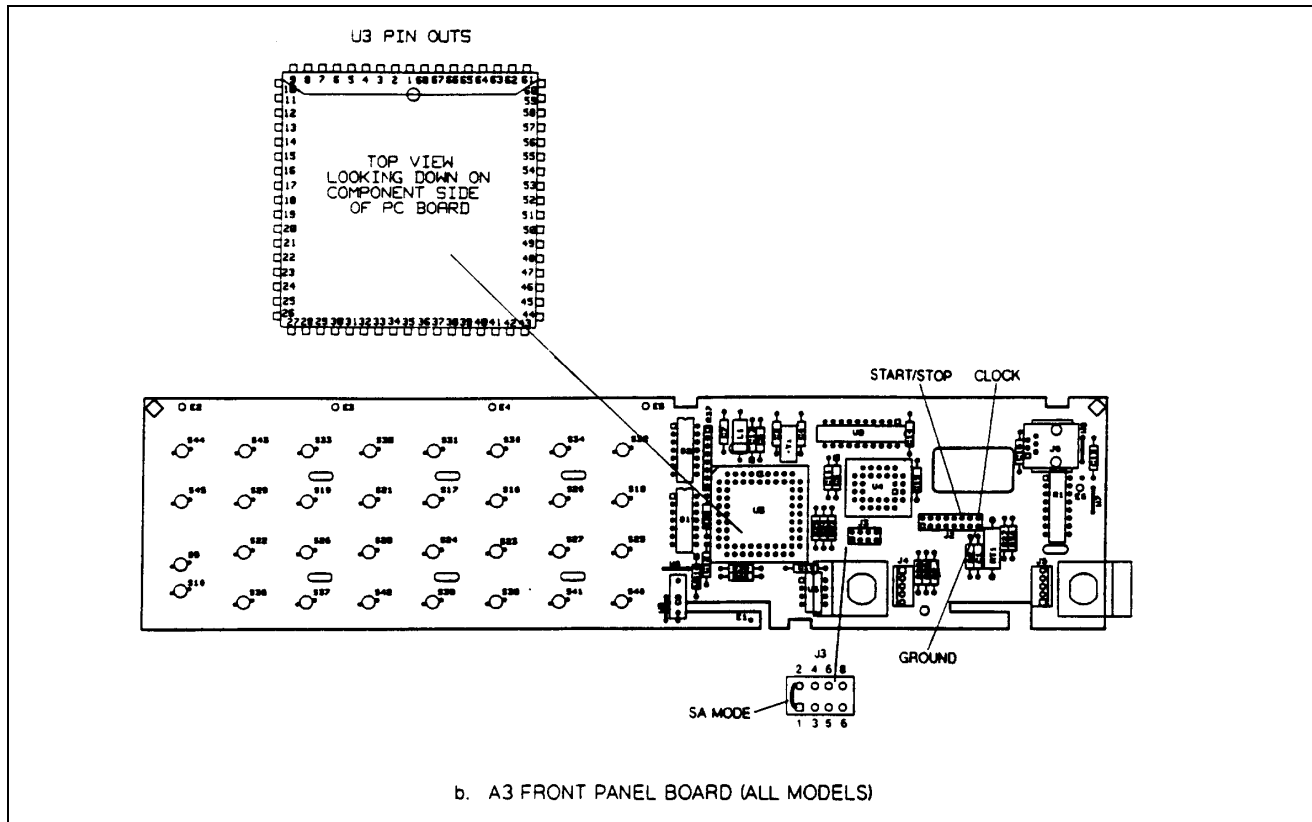

Figure 3-16. Signature Analysis Connections, (Sheet 2 of 2)

Table 3-6. Front Panel SA Test

Description: These signatures check front panel microprocessor AIU3.	
Valid A1U4 ROM Firmware Revision: A.01.07	
Test Setup: See Figure 3-17.	
1. Turn off the power supply and remove the top cover.	
2. To gain access to A1 Front Panel Board, perform steps 1 and 2 of the disassembly procedure for A1 Front Panel Assembly (see "Disassembly Procedures").	
3. Connect SA jumper of connector J3 on A1 Front Panel Board (see Figure 3-15).	
4. Connect signature analyzer CLOCK, START, STOP, and GROUND inputs and setup as shown in Figure 3-16.	
5. Turn on the power supply and use the signature analyzer probe to take the following signatures:	
Power:	5V = 3395
Microprocessor:	AIU3-15 = 3395
	AIU3-19 = 552U
	AIU3-20 = 954C
	AIU3-21 = A552
	AIU3-22 = 2954
	AIU3-23 = 0A55
	AIU3-24 = 3395
	AIU3-25 = 3395
	AIU3-26 = 0000
	AIU3-27 = 0000
	AIU3-28 = 40A5
	AIU3-29 = 1029
	AIU3-30 = 0295
	AIU3-31 = 0000
	AIU3-32 = 3395
	AIU3-33 = 0008
	AIU3-34 = 040A
	AIU3-35 = 0102
	AIU3-38 = 0002
	AIU3-39 = 0020
	AIU3-42 = 3395
6. After completing the tests, be sure to return the J3 jumper to its original position.	

Table 3-7. Secondary Interface SA Test

<p>Description: These signatures check the secondary microprocessor A5U504. Valid A5U504 ROM Firmware Revision: A.01.04 Test Setup: See Figure 3-17.</p>																																									
1. Turn off the power supply and remove the top cover.																																									
2. To obtain a setup that allows access to components and test points on the A5 Control Board, follow the procedure given in Table 3-3 under "A5 Control Board Setup".																																									
3. Connect signature analyzer CLOCK, START, STOP, and GROUND inputs and setup as shown in Figure 3-15.																																									
4. To place the secondary interface in the SA mode, turn on the power supply while momentarily (for 2 seconds) shorting A5U504-1 to A5U504-20 (common).																																									
5. Use the signature analyzer probe to take the following signatures:																																									
Power:	5V = IC4C																																								
Microprocessor:	<table border="0"> <tr> <td>A5U504-1 = F77H</td> <td>A5U504-21 = 0C98</td> </tr> <tr> <td>A5U504-2 = C98P</td> <td>A5U504-22 = 5PC7</td> </tr> <tr> <td>A5U504-3 = 1573</td> <td>A5U504-23 = 0000</td> </tr> <tr> <td>A5U504-4 = P42A</td> <td>A5U504-24 = 6CAP</td> </tr> <tr> <td>A5U504-5 = UHF8</td> <td>A5U504-25 = A339</td> </tr> <tr> <td>A5U504-6 = F5UC</td> <td>A5U504-26 = A319</td> </tr> <tr> <td>A5U504-7 = UH8C</td> <td>A5U504-27 = A339</td> </tr> <tr> <td>A5U504-8 = 23UC</td> <td>A5U504-28 = 0C98</td> </tr> <tr> <td>A5U504-9 = 0000</td> <td>A5U504-29 = IC4C</td> </tr> <tr> <td>A5U504-10 = IC4C</td> <td>A5U504-30 = 0000</td> </tr> <tr> <td>A5U504-11 = IC4C</td> <td>A5U504-31 = IC4C</td> </tr> <tr> <td>A5U504-12 = C76F</td> <td>A5U504-32 = 0000</td> </tr> <tr> <td>A5U504-13 = U042</td> <td>A5U504-33 = 0000</td> </tr> <tr> <td>A5U504-14 = 2189</td> <td>A5U504-34 = IC47</td> </tr> <tr> <td>A5U504-15 = IC4C</td> <td>A5U504-35 = 0000</td> </tr> <tr> <td>A5U504-16 = IC45</td> <td>A5U504-36 = 0UPU</td> </tr> <tr> <td>A5U504-17 = 0010</td> <td>A5U504-37 = UF7P</td> </tr> <tr> <td>A5U504-18 = IC4C</td> <td>A5U504-38 = 347F</td> </tr> <tr> <td>A5U504-19 = IC4C</td> <td>A5U504-39 = CP47</td> </tr> <tr> <td>A5U504-20 = 0000</td> <td>A5U504-40 = IC4C</td> </tr> </table>	A5U504-1 = F77H	A5U504-21 = 0C98	A5U504-2 = C98P	A5U504-22 = 5PC7	A5U504-3 = 1573	A5U504-23 = 0000	A5U504-4 = P42A	A5U504-24 = 6CAP	A5U504-5 = UHF8	A5U504-25 = A339	A5U504-6 = F5UC	A5U504-26 = A319	A5U504-7 = UH8C	A5U504-27 = A339	A5U504-8 = 23UC	A5U504-28 = 0C98	A5U504-9 = 0000	A5U504-29 = IC4C	A5U504-10 = IC4C	A5U504-30 = 0000	A5U504-11 = IC4C	A5U504-31 = IC4C	A5U504-12 = C76F	A5U504-32 = 0000	A5U504-13 = U042	A5U504-33 = 0000	A5U504-14 = 2189	A5U504-34 = IC47	A5U504-15 = IC4C	A5U504-35 = 0000	A5U504-16 = IC45	A5U504-36 = 0UPU	A5U504-17 = 0010	A5U504-37 = UF7P	A5U504-18 = IC4C	A5U504-38 = 347F	A5U504-19 = IC4C	A5U504-39 = CP47	A5U504-20 = 0000	A5U504-40 = IC4C
A5U504-1 = F77H	A5U504-21 = 0C98																																								
A5U504-2 = C98P	A5U504-22 = 5PC7																																								
A5U504-3 = 1573	A5U504-23 = 0000																																								
A5U504-4 = P42A	A5U504-24 = 6CAP																																								
A5U504-5 = UHF8	A5U504-25 = A339																																								
A5U504-6 = F5UC	A5U504-26 = A319																																								
A5U504-7 = UH8C	A5U504-27 = A339																																								
A5U504-8 = 23UC	A5U504-28 = 0C98																																								
A5U504-9 = 0000	A5U504-29 = IC4C																																								
A5U504-10 = IC4C	A5U504-30 = 0000																																								
A5U504-11 = IC4C	A5U504-31 = IC4C																																								
A5U504-12 = C76F	A5U504-32 = 0000																																								
A5U504-13 = U042	A5U504-33 = 0000																																								
A5U504-14 = 2189	A5U504-34 = IC47																																								
A5U504-15 = IC4C	A5U504-35 = 0000																																								
A5U504-16 = IC45	A5U504-36 = 0UPU																																								
A5U504-17 = 0010	A5U504-37 = UF7P																																								
A5U504-18 = IC4C	A5U504-38 = 347F																																								
A5U504-19 = IC4C	A5U504-39 = CP47																																								
A5U504-20 = 0000	A5U504-40 = IC4C																																								
6. After completing the tests, be sure to return the J3 jumper to its original position.																																									

Note After completing this test, you can exit the SA mode only by performing a power-on reset.

Post-Repair Calibration

When Required

Calibration is required annually and also whenever certain components are replaced. If components in any of the circuits listed below are replaced, the supply must be recalibrated.

Note For calibration procedures, see Appendix A of the Operating Manual.

Location	Component
A10 Control Board	CV/CC DACs/operational amplifiers, CV/CC control circuit amplifiers, readback DAC/operational amplifier, readback comparators.
A1 Front Panel Assy	A1 Front Panel Board or EEPROM AIU6. Note: If either of these front panel components is replaced, the power supply must first be reinitialized before calibration (see "EEPROM Initialization").

Inhibit Calibration Jumper

If **CAL DENIED** appears on the display when front panel calibration is attempted (or error code 1 occurs when GPIB calibration is attempted on a Systems Supply), the INHIBIT CAL jumper (see Figure 3-15) is installed. This prevents the power supply calibration from being changed. To calibrate the power supply first move this jumper from the INHIBIT CAL position to the NORM position.

Calibration Password

In order to enter the calibration mode, you must use the correct password as described in Appendix A of the Operating Manual. As shipped from the factory, the supply's model number (e.g., "6681") is the password. If you use an incorrect password, **PASSWD ERROR** appears on the display during front panel calibration, or error code 2 occurs during GPIB calibration, and the calibration mode is disabled. If you do not know the password, you can recover the calibration function by restoring the preset factory calibration constants as described below.

Restoring Factory Calibration Constants

This procedure allows you to recover the factory calibration constants. The ability to do this allows you to operate the power supply for troubleshooting and/or to recalibrate it as required. To restore the original factory calibration constants, proceed as follows:

1. Turn off the supply and remove the top cover.
2. Move the jumper in test header J3 on the A1 Front Panel Board from the **NORM** to the **FACTORY PRESET CAL** position (see Figure 3-15).
3. Turn on the power supply and note that **ADDR 5** and then **PWR ON INIT** appear briefly on the front panel display.
4. When **PWR ON INIT** no longer appears, the supply's factory calibration constants have been restored and the password has been changed to 0. There is no longer any password protection. You can now turn off the supply and restore the calibration jumper to the **NORM** position (see Figure 3-15).
5. Turn on the supply. You may now set a new password (if desired) and recalibrate the power supply.

EEPROM Initialization

EEPROM AIU6 on the A1 Front Panel Board stores the supply's GPIB address, model number, and constants required to program and calibrate the power supply. If either the front panel board or the EEPROM is replaced, the power supply must be reinitialized with the proper constants by running the program listed in Figure 3-18.

When the program pauses and asks you to make a selection, respond as follows:

Initialization (I) or Factory Preset Replacement (F)? I

After the power supply has been initialized, it must be calibrated as described in Appendix A of the Operating Manual. After calibration, transfer the new calibration constants to the EEPROM's "Factory Cal" locations as described next.

Transferring Calibration Constants To Factory Preset Locations

A newly initialized and calibrated power supply has calibration constants in operating locations but does not have the new factory calibration constants stored in EEPROM. This procedure transfers the calibration constants into the EEPROM FACTORY PRESET CAL locations by running the program listed in Figure 3-18.

When the initialization program pauses and asks you to make a selection, respond as follows:

Initialization (I) or Factory Preset Replacement (F)? F

The new calibration constants will then be stored. Pre-initialized and tested A1 Front Panel boards are available for Analog Programmable "bench" series supplies. (See Chapter 5, Table 5-4 for part numbers.)

A Bench Series Supply can be initialized and the new Factory Preset calibration constants loaded by temporarily replacing the A2 Isolator board with an A2 GPIB board. Then follow the instructions above for "EEPROM INITIALIZATION" and also "TRANSFERRING CALIBRATION CONSTANTS TO THE FACTORY PRESET LOCATIONS" described above.

After the supply has been Initialized, Calibrated, and the new Factory Presets stored, remove the GPIB board and reinstall the original Isolator board.

```

10 ! Program to initialize EPROM or move factory preset data in 668xA
20 ! power supplies.
30 ! RE-STORE " INIT_668X"
40 ! Rev A.00.00 dated 09 Nov 1993
50 !
60 DIM Init_data(1:49),Model$(5),Idn$(21),Cal_data$(40)
70 INTEGER Addr(1:49),Length(1:49)
80 ASSIGN @Ps TO 705 ! Supply must be at address 705
90 CLEAR SCREEN
100 !
110 Eprom_data_addr: ! Data address
120 DATA 2,6,10,14,18,19,20,24,28,32
130 DATA 36,37,38,42,46,50,54,55,56,57
140 DATA 64,68,72,76,80,116,152,153,154,155
150 DATA 156,158,160,162,163,164,165,166,167,168
160 DATA 169,170,171,172,174,176,180,184,188
170 !
180 Eprom_data_len: ! Data for word length
190 DATA 4,4,4,4,1,1,4,4,4,4
200 DATA 1,1,4,4,4,4,1,1,1,1
210 DATA 4,4,4,4,4,1,1,1,1,1
220 DATA 2,2,2,1,1,1,1,1,1,1
230 DATA 1,1,1,2,1,4,4,4,4
240 !
250 Eprom_data_6680: ! EEPROM data for 6680A
260 DATA 729,71,5.125,0,83,0,4.235,72,895,0
270 DATA 98,3,36,17,6.25,0,83,255,20,10
280 DATA 6680,708,94,4.13,92,128,5,255,0,0
290 DATA 1296,6680,0,20,180,20,180,175,33,98
300 DATA 115,30,20,1,58,.002701,.2,.0017346,10.2286
310 !
320 Eprom_data_6681: ! EEPROM data for 6681A
330 DATA 463,75,8.19,0,83,0,6.333,70,592,0
340 DATA 98,3,22.16,17.75,10,0,0,.83,255,20,10
350 DATA 6681,430,95,6.3645,92,128,5,255,0,0
360 DATA 1296,6681,0,20,180,20,180,175,33,98
370 DATA 115,30,20,1,58,.002701,.2,.0017346,10.2286
380 !
390 Eprom_data_6682: ! EEPROM data for 6682A
400 DATA 175,74,21.5,0,83,0,15,73,246,0
410 DATA 98,21,8.7,10,26.3,0,83,255,20,10
420 DATA 6682,162,96,15,96,128,5,255,0,0
430 DATA 1296,6682,0,20,180,20,180,175,33,98
440 DATA 115,30,20,1,127,.002701,.2,.000307,10.25
450 !
460 Eprom_data_6683: ! EPROM data for 6683A
470 DATA 116,74,32.8,0,83,0,23,75,164,0
480 DATA 98,21,5.5,10,40,0,0,83,255,20,10
490 DATA 6683,108,96,23,97,128,5,255,0,0
500 DATA 1296,6683,0,20,180,20,180,175,33,98

```

Figure 3-17. Initialization and Factory Preset Replacement Program Listing (Sheet 1 of 5)

```

510 DATA 115,30,20,1,127,.002701,.2,.00042,10.25
520 !
530 Eprom_data_6684: ! ! EEPROM data for 6684A
540 DATA 93,74,41,0,83,0,29,70,131,0
550 DATA 98,21,4.6,10,50,0,83,255,20,10
560 DATA 6684,87,97,28,93,128,5,255,0,0
570 DATA 1296,6684,0,20,180,20,180,175,33,98
580 DATA 115,30,20,1,127,.002701,.2,.000333,10.234375
590 !
600 !
610 INPUT "Input Power Supply model number. Example: ""6681A""",Model$
620 CLEAR SCREEN
630 !
640 RESTORE Eprom_data_addr
650 !
660 FOR I=1 TO 49
670 READ Addr(I)
680 NEXT I
690 !
700 RESTORE Eprom_data_len
710 !
720 FOR I=1 TO 49
730 READ Length(I)
740 NEXT I
750 !
760 SELECT TRIM$(UPC$(Model$)) ! Delete leading/trailing zeros and set to uppercase
770 CASE "6680A"
780 RESTORE Eprom_data_6680
790 CASE "6681A"
800 RESTORE Eprom_data_6681
810 CASE "6682A"
820 RESTORE Eprom_data_6682
830 CASE "6683A"
840 RESTORE Eprom_data_6683
850 CASE "6684A"
860 RESTORE Eprom_data_6684
870 !
880 CASE ELSE
890 PRINT "Model number not found. Program is for models"
900 PRINT "Agilent 6680A, 6681A, 6682A, 6683A and 6684A only"
910 STOP
920 END SELECT
930 !
940 FOR I=1 TO 49 ! Read model dependent data
950 READ Init_data(I)
960 NEXT I
970 !
980 OUTPUT @Ps;"*CLS" ! Clears power supply registers
990 !
1000 OUTPUT @Ps;"CAL;STATE ON," ! Turn on cal mode, "0" passcode
1010 !

```

Figure 3-17. Initialization and Factory Preset Replacement Program Listing (Sheet 2 of 5)

```

1020 GOSUB Ps_error                ! Error if passcode is not "0"!
1030 IF Err THEN
1040     OUTPUT @Ps;"*IDN?"        ! Get data from model # location
1050     ENTER @Ps;Idn$
1060     Model=VAL(Idn$[POS(Idn$,"")+1] )
1070 ELSE
1080     GOTO Start
1090 END IF
1100 !
1110 OUTPUT @Ps;"CAL:STATE ON,";Model    ! Turn on cal mode, passcode =
1120                                     ! data at model number location
1130 !
1140 GOSUB Ps_error                ! Error if passcode is not same as
1150                                     ! data at model # location
1160 IF Err THEN
1170     OUTPUT @Ps;"CAL:STATE ON,";Model$[1,4]    ! Turn on cal mode, passcode =
1180                                     ! model #
1190     GOSUB Ps_error
1200     IF Err THEN
1210         PRINT "Change pass code to the power supply model # or zero then restart the program."
1220         STOP
1230     ELSE
1240         GOTO Start
1250     END IF
1260 END IF
1270 !
1280 Start:    !
1290          !
1300          !
1310 INPUT "Select Initialization (I) or Factory preset replacement (F).",Sel$
1320 CLEAR SCREEN
1330 SELECT (UPC$(Sel$))
1340 CASE "I"                ! Select Initialization
1350     GOTO Init_eeprom
1360 CASE "F"                ! Select install new factory data
1370     GOTO Fact_preset
1380 CASE ELSE
1390     BEEP
1400     GOTO Start
1410 END SELECT
1420 !
1430 Init_eeprom:    !
1440 PRINT "Initializing EEPROM"
1450 !
1460 FOR I=1 TO 49
1470     OUTPUT @Ps;"DIAG:EEPR ";Addr(I);";Length(I);";Init_data(I)
1480 NEXT I
1490 GOTO Cal_off
1500 !
1510 !
1520 Fact_preset:    !

```

Figure 3-17. Initialization and Factory Preset Replacement Program Listing (Sheet 3 of 5)

```

1530 CLEAR SCREEN
1540 PRINT "This program should ONLY be completed if your power supply"
1550 PRINT "EEPROM has been replaced or a component that will effect"
1560 PRINT "the calibration AND the alignment of voltage, overvoltage"
1570 PRINT "and current is complete AND unit has passed the performance"
1580 PRINT "test.          Enter C to continue, any other key to abort."
1590 INPUT Cont_prog$
1600 IF (UPC$(Cont_prog$))<>"C" THEN GOTO Cal_off
1610 !
1620 CLEAR SCREEN
1630 PRINT "Transferring calibration data to factory preset locations."
1640 !
1650 Fact_cal_sour:      ! Address of factory calibration data source
1660 DATA 2,6,68,72,20,24,76,80,150
1670 !
1680 Fact_cal_dest      :  ! Address of factory calibration data destination
1690 DATA 84,88,92,96,100,104,108,112,116
1700 !
1710 Fact_cal_len:      ! Length of factory calibration data
1720 DATA 4,4,4,4,4,4,4,4,1
1730 !
1740 RESTORE Fact_cal_sour
1750 FOR I=1 TO 9
1760 READ Cal_sour_addr(I)
1770 NEXT I
1780 !
1790 RESTORE Fact_cal_dest
1800 FOR I=1 TO 9
1810 READ Cal_dest_addr(I)
1820 NEXT I
1830 !
1840 RESTORE Fact_cal_len
1850 FOR I=1 TO 9
1860 READ Cal_length(I)
1870 NEXT I
1880 !
1890 FOR I=1 TO 9          ! Locations of good data
1900 OUTPUT @Ps;"DIAG:EEPR? ";Cal_sour_addr(I);",";Cal_length(I) ! Read good data
1910 ENTER @Ps;Cal_data$ ! Enter good data
1920 OUTPUT @Ps;"DIAG:EEPR";Cal_dest_addr(I);",";Cal_length(I);",";Cal_data$
! Write good data to factory preset locations
1930 NEXT I
1940 !
1950 !
1960 Cal_off
1970 CLEAR SCREEN
1980 OUTPUT @Ps;"CaL:STATE OFF"          ! Turn off cal mode
1990 !
2000 GOSUB Ps_error          ! Check for errors

```

Figure 3-17. Initialization and Factory Preset Replacement Program Listing (Sheet 4 of 5)

```

2010 IF Err THEN
2020     PRINT "An error occurred during the EEPROM read/write, Check for"
2030     PRINT "programming errors. Initialization data may be incorrect."
2040     STOP
2050 END IF
2060 !
2070 PRINT "Operation complete. Program stopped."
2080 STOP
2090 !
2100 Ps_error:                                ! Error handling subroutine
2110     OUTPUT @Ps;"SYST:ERR?"                ! Check for errors
2120     ENTER @Ps;Err
2130     RETURN
2140     !
2150     END

```

Figure 3-17. Initialization and Factory Preset Replacement Program Listing (Sheet 5 of 5)

Disassembly Procedures

WARNING

Shock Hazard: To avoid the possibility of personal injury, remove the power supply from service before removing the top cover. Turn off the ac power and disconnect the line cord, GPIB cable, load leads, and remote sense leads before attempting any disassembly. Any disassembly work must only be performed by a qualified support technician.

Observe that the DC RAIL assembly LEDs (DS420 & DS421) are fully extinguished (no live voltages present) before attempting any disassembly work. Any disassembly work must only be performed by a qualified support technician.

Cable connections are shown in Figure 6-2 of Chapter 6 and component part numbers are given in Chapter 5. Reassembly procedures are essentially the reverse of the corresponding disassembly procedures.

Tools Required

- ⌘ TORX screwdriver size T-15 (for most all retaining screws).
- ⌘ TORX screwdriver size T-20 (for power supply carry straps).
- ⌘ Seven (7) mm metric hex driver (to remove GPIB read connector).
- ⌘ Pencil, paper, and labels to make notes to aid in the reinstallation of components.
- ⌘ Work at a static-free station such as a table covered with static-dissipative laminate or with a conductive table mat (Agilent P/N 9300-0797, or equivalent) using a conductive wrist strap where necessary, such as, Agilent P/N 9300-0969 or 9300-0970.

Top Cover

1. Remove the four screws that secure the carrying straps (two TORX 20 screws on each side). These same screws secure the cover to the chassis.
2. Spread the bottom rear of the cover, and then pull the cover backwards towards the rear of the power supply to disengage it from the front panel.

WARNING

Shock Hazard: Hazardous voltage can exist inside the power supply even after it has been turned off. Check the INPUT RAIL LED (A4CR402) under the RFI shield (see Figure 3-18 end of this section for LED location). If the LED is on, there is still hazardous voltage inside the supply. Wait until the LED goes off (*approximately 7 minutes after power is removed*) before proceeding.

Removing Protective RFI Shield (Galvanized Sheet Metal)

Once you remove the top cover of the power supply, you will see the RFI galvanized sheet metal cover preventing the power supply from emanating RFI fields. The RFI shield covers most components and circuit boards, as well as, many of the chassis-mounted components. You must remove this shield in order to gain access to the inside of the power supply. Remove the shield as follows:

1. There are approximately 21 screws holding the cover to the frame.
2. There are two screws at the top of the shield that secure a retaining clip for the GPIB board. You do not need to remove these screws, simply loosen the screws and slide the GPIB retaining clip backwards free of the GPIB board.
3. Remove all shield securing screws using a TORX T-15 screwdriver and save for later reinstallation .
4. Lift the RF shield out of the chassis.
5. When DC RAIL LEDs are extinguished, it is safe to work inside the power supply. (See Warning note above.)

Note

The following procedures describe the removal of most of the circuit boards within the power supply. Once the GPIB board is removed, you will have access to the A4 AC Input Assembly and the A5 DC Rail Assembly. Similarly, once the A10 control board is removed along with the Rectifier HS you will have access to other components and boards within the supply.

It is recommended that when you disconnect any wires and/or cable connectors you should immediately label them to simplify their reinstallation later.

GPIB Board

To remove the GPIB board, disconnect the cables from the following connectors at the GPIB board:

1. Disconnect the cable going to connector P101.
2. Disconnect phone cable going to J107.
3. Disconnect phone cable going to J107.
4. Disconnect phone cable going to J108.
5. Remove two (2) holding screws at rear of chassis holding GPIB board in place.
6. Using a 7 mm driver, remove the two (2) screws holding the GPIB connector at rear of chassis.
7. The GPIB board can now be lifted out from the chassis.

A4 AC Input Assembly

To remove the A4 AC Input Board first remove the GPIB board then disconnect these cables from the following connectors at the GPIB board:

1. Disconnect the cables going to connector J417 and J420.
2. Disconnect the cable going to connector J419.
3. Remove the three (3) fuse assemblies inside rear of power supply to free the wires going to E400, E401, and E402 on the AC Input Board.
4. Remove the holding screw at the center of board just to the left of the 3-phase choke.
5. Disconnect phone cable going to J108.
6. Slide the board to the right and lift out.
7. Other wires going to the board can now be removed/unsoldered.

A5 DC RAIL Assembly

Disconnect these cables from the following connectors at the A5 DC RAIL board:

1. Disconnect the cables going to four connectors: J430, J431, J432, and J433.
2. Disconnect the cable going to connector J440.
3. Remove the four (4) holding screws TORX T-15 holding the A5 DC RAIL board in place.
4. Lift the board out and remove/desolder any other wires preventing the board from being removed.

A6 BIAS Assembly

Disconnect the cables from the following connectors at the A6 BIAS Assembly board:

1. Disconnect cables from connectors J809, J821, J830, and J831 on the A6 BIAS Board.
2. Remove two (2) holding screws at top side of board.
3. Slide board upward until board is free of slotted standoffs. There is one of these standoffs at the top of the board and two at the bottom. Wiggle the board slightly to clear all three standoffs then lift the board out.
4. Once the board is free from its restraining standoffs, you can proceed to remove/unsolder any other wires/cables as necessary to remove the A6 BIAS Board entirely.

Note

It is recommended that you label any connectors you disconnect from the A6 BIAS Board to facilitate the reinstallation of these cables/wires back to their correct locations later. If you should have trouble later in determining which cable goes to which connector during reinstallation, refer to the cabling diagram in Chapter 6.

A3 FET Board

Follow this procedure to remove the A3 FET Board:

1. Remove the four (4) holding screws that secure the two black caps over the Rectifier HS assembly.
2. Once these caps are removed, you can remove the Rectifier HS which faces the A3 FET Board.
3. Disconnect two connectors, P430 and P431, at the A5 DC RAIL assembly.
4. Disconnect two connectors P/O cable assemblies P/N 5080-2283, at the A5 DC RAIL assembly.
5. You can now lift out the A3 FET board and remove/unsolder any other wires necessary to fully remove the A3 board.

A10 Control Assembly

Disconnect the cables from the following connectors at the A10 DC RAIL board:

1. Disconnect the ribbon cable going from to the A6 Bias board. This cable connects to J509 on the A10 board but it is easier to disconnect it at the A6 Bias Board.
2. Disconnect cables from connector J507 (phone) and connectors J510, J511, J512, and J513 on the A10 Control Board.
3. At rear of power supply, remove holding screw directly above fan. This screw holds the frame and A10 control board in place.
4. At rear of power supply unplug connector DIG CNTL from A10 Control Board.
5. Move board to the right and lift board and associated steel frame out of chassis.

Front Panel Assembly

1. Peel off vinyl trim (one strip on each side of front panel) to access the four screws that secure the front panel assembly to the chassis.
2. Remove the four screws (two on each side) using a size T-10 TORX.
3. Disconnect phone cable W5 from J6 on the A1 Front Panel Board.
4. Record the color code and the location of each of the four wires connected to line switch S1.
5. Disconnect the wires from the switch assembly.
6. Remove the front panel assembly.

S1 Line Switch

1. Remove Front Panel Assembly and disconnect switch wires as described in that procedure.
2. Release the switch locking tabs by pressing them inward against the body of the switch and removing the switch.

A1 Front Panel Board

1. Remove the Front Panel Assembly and disconnect the switch as described under "Front Panel Assembly".
2. Disconnect LCD display ribbon cable W2 from J2 on the A1 Front Panel Board.

Note When reinstalling the LCD ribbon cable, be sure to line up the "stripe" of the ribbon cable with pin 1 on J2.

3. Use a small Allen wrench (0.050") to loosen the set screws that are inset in the knobs. (These are the AIG1 and AIG2 Voltage/Current control shafts that extend through the front panel.) Remove knobs and shaft bushings.

Note Be careful not to unscrew the knob set screws too far out as they can easily fall out of the knob and become lost.

4. Remove screw (if installed) that secures board to the Front Panel Assembly. The screw is located near J4 on the Front Panel Board.
5. Lift tab (near J6 on front panel board) and slide left to release board from the A1 Front Panel Assembly and remove board.

A1DSP1 LCD Display

1. Remove the A1 Front Panel Board as described in that procedure.
2. Remove the nuts securing the LCD display to the front panel assembly and remove the LCD and attached ribbon cable (see CAUTION below). (When reinstalling this cable, be sure to line up the cable stripe over the LCD connector pin marked with a square.)

CAUTION

The display connector is fragile. When removing the cable from the LCD display, carefully rock the cable connector back and forth while gently pulling it back.

A1G1 and A1G2 Rotary Controls

1. Remove the A1 Front Panel Board as described in that procedure.
2. Remove the A1G1 and A1G2 cables from connectors A1J4 and A1J5.
3. Remove nuts securing the A1G1 A1G2 controls to the board and remove controls.

A1KPD Keypad

1. Remove the A1 Front Panel Board as described in that procedure.
2. With board removed, keypad can easily be lifted out of the Front Panel Assembly.

Output Bus Boards A7, A81 and A9 & Chassis Components

Note

To remove the A7 Snubber Board, A8 Fast Sense Assembly, A9 Downprogrammer and other chassis mounted components, first remove the A10 Control Board frame assembly and the two Rectifier Heat Sinks described earlier. Once the heat sinks are removed you will have access to the A7, A8, and A9 boards as well as other chassis mounted components.

Should you have any difficulty in removing power supply components or boards, contact the Agilent Technologies Support Line for help.

WARNING

Shock Hazard: Hazardous voltage can exist inside the power supply even after it has been turned off. Check the INPUT RAIL LED (A4CR402) under the RFI shield (see Figure 3-18 end of this section for LED location). If the LED is on, there is still hazardous voltage inside the supply. Wait until the LED goes off (*approximately 7 minutes after power is removed*) before proceeding.

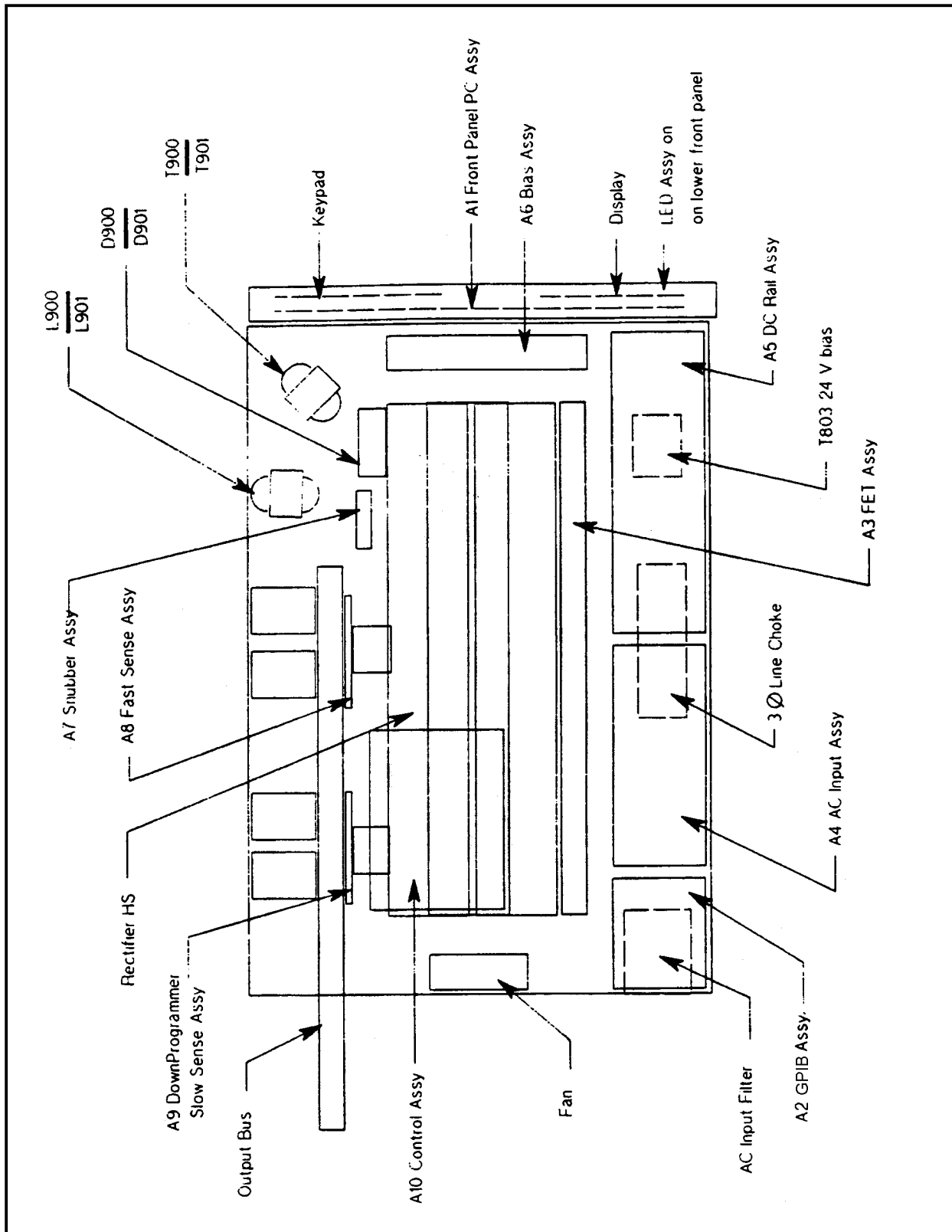

Figure 3-18. Component Locations (Top Cover and RFI Shield Removed)

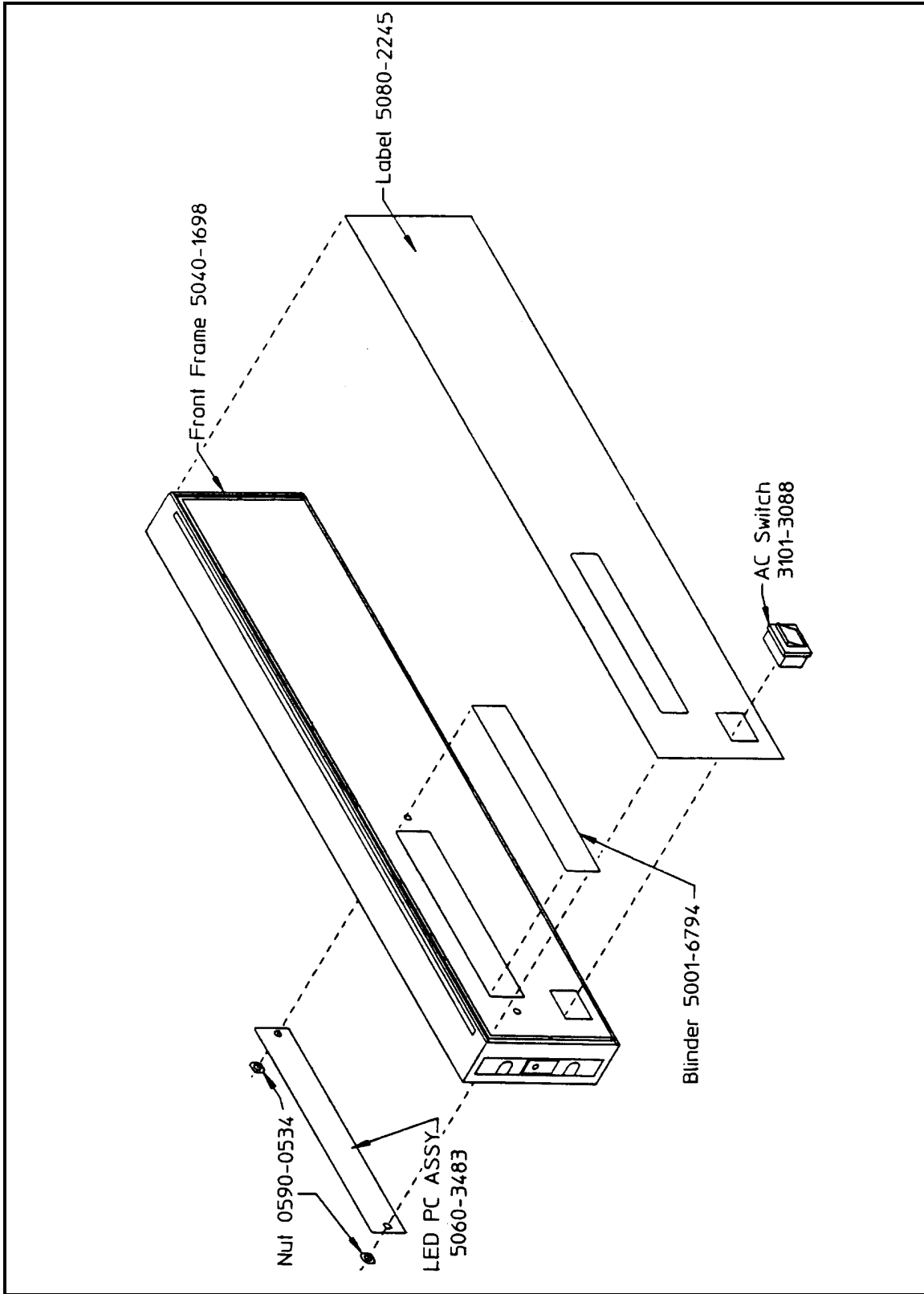

Figure 3-19. 5-Inch Front Panel Frame Assembly

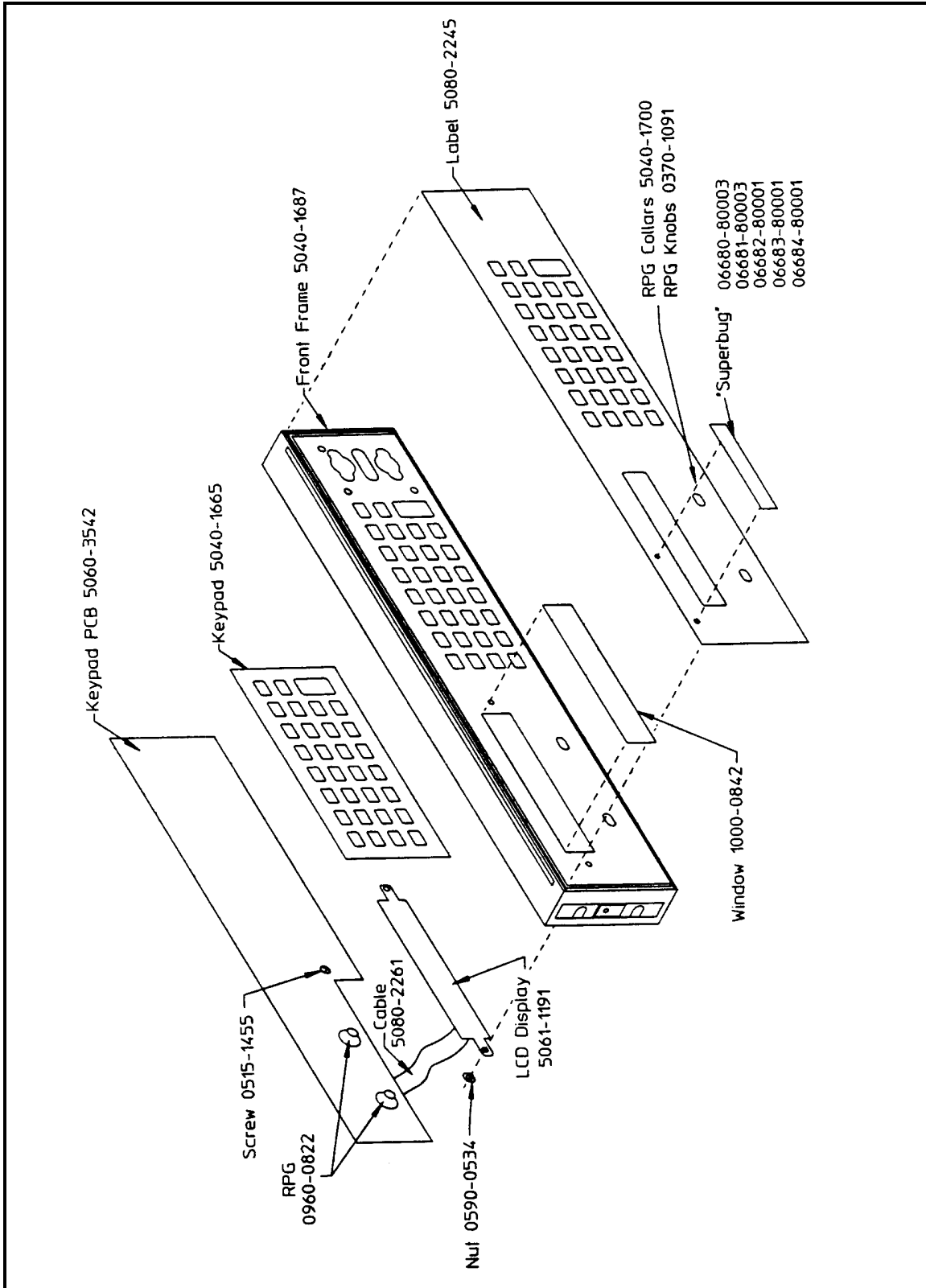

Figure 3-20. 3-Inch Front Panel Frame Assembly

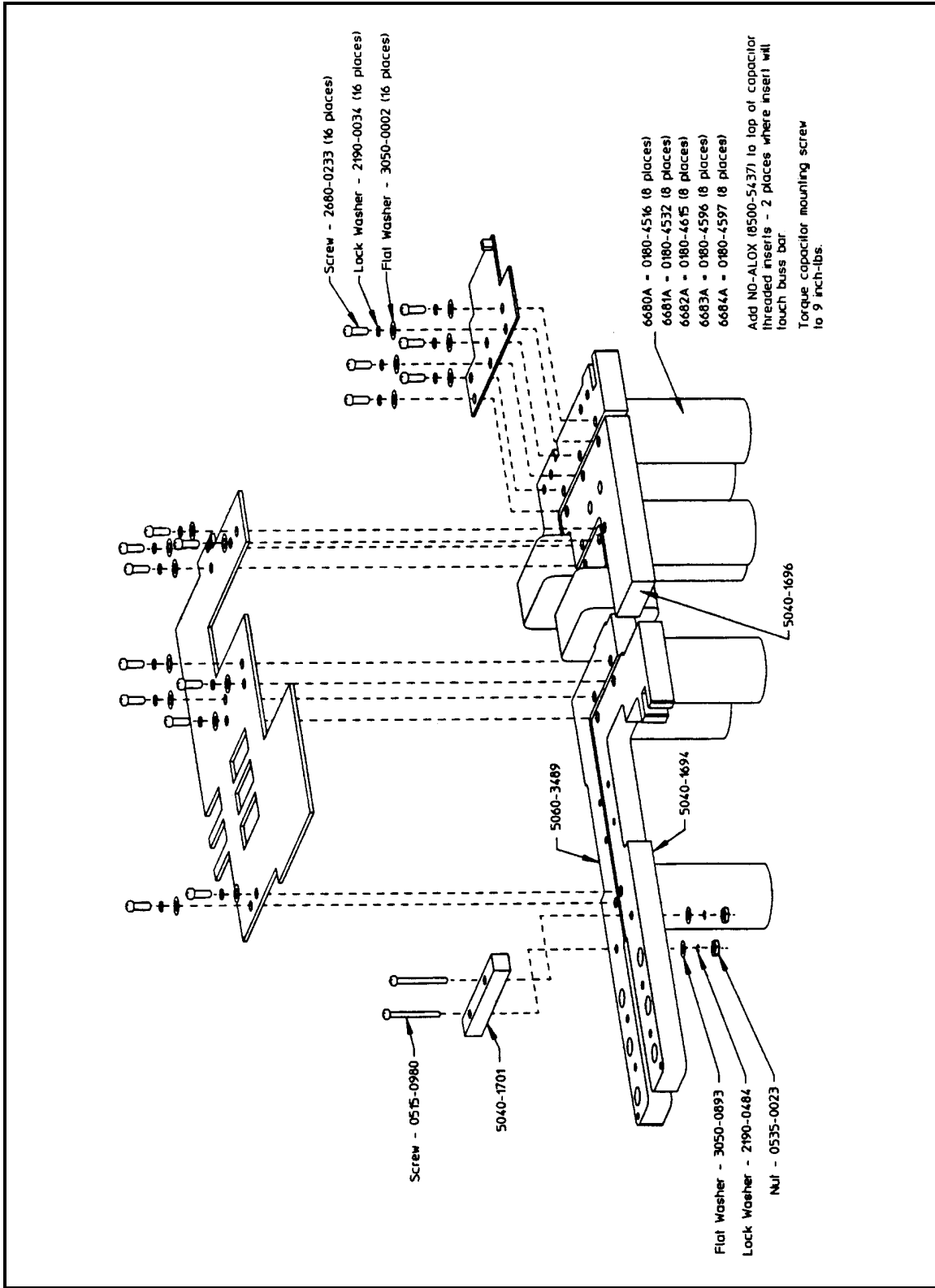

Figure 3-21. Assembly A10, Exploded View

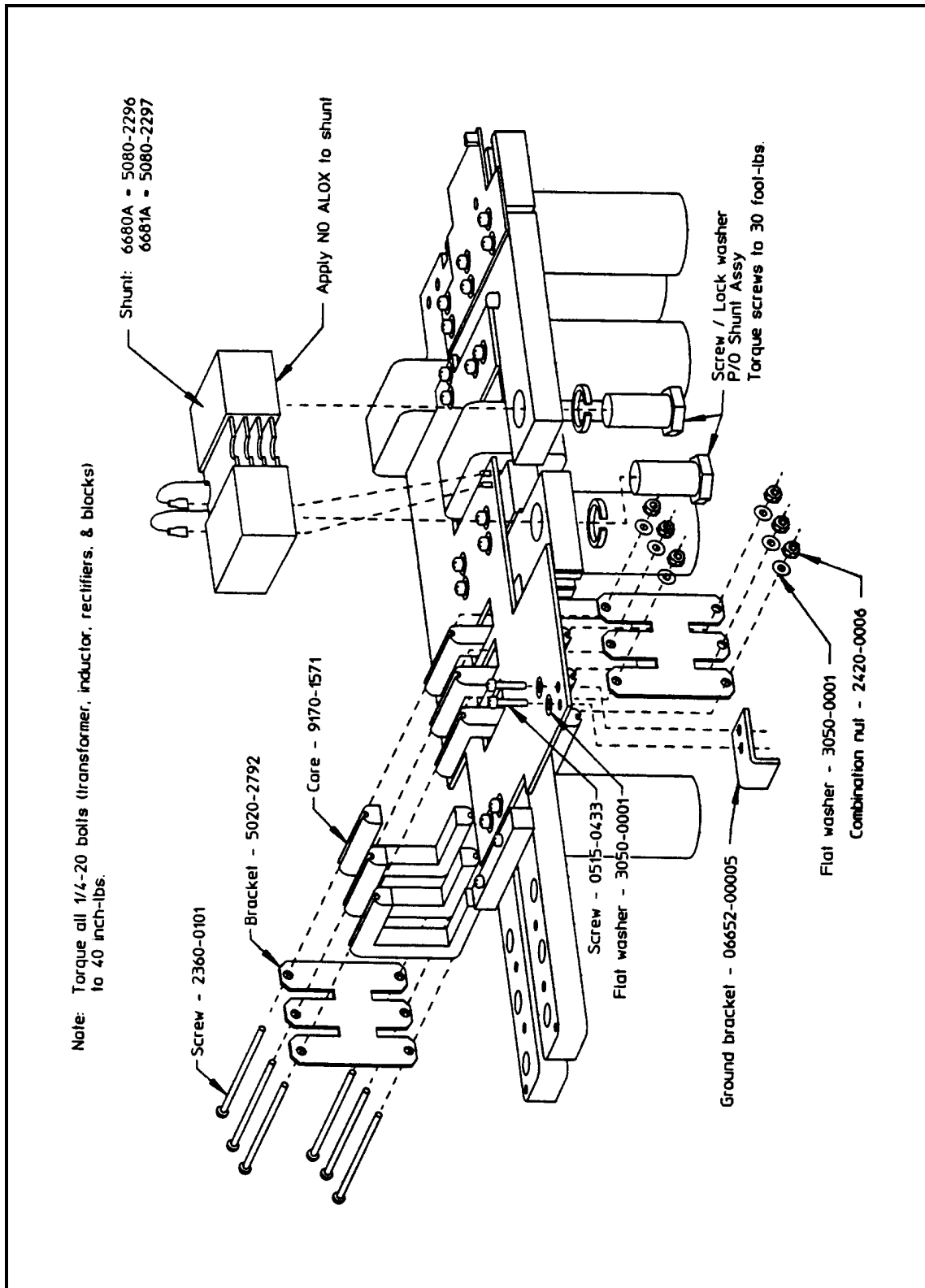

Figure 3-22. Assembly A10, Exploded View (6680A, 6681A)

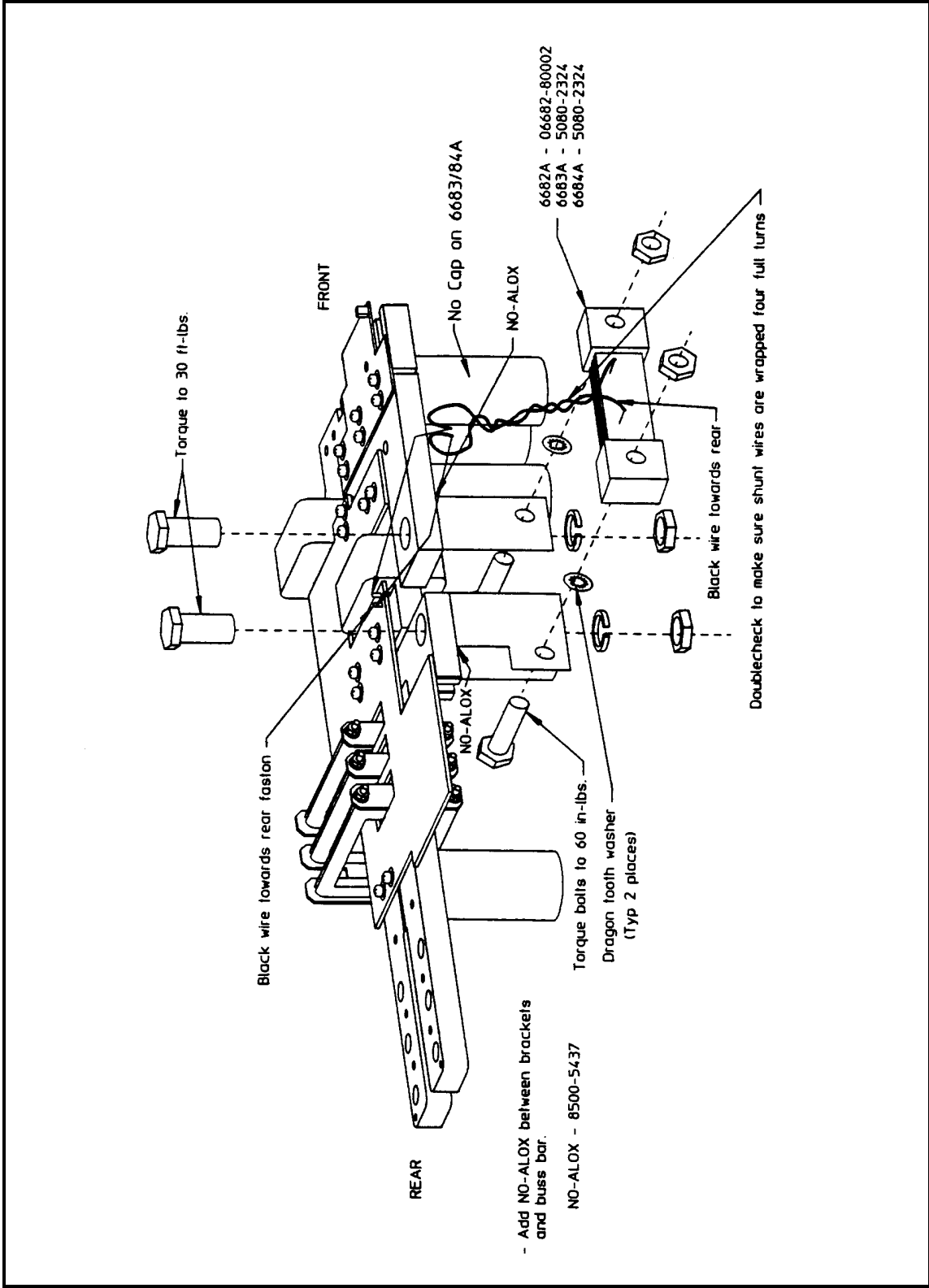

Figure 3-23. Assembly A10, Exploded View (6682A, 6683A, 6684A)

5080-2262 3Ø-Choke

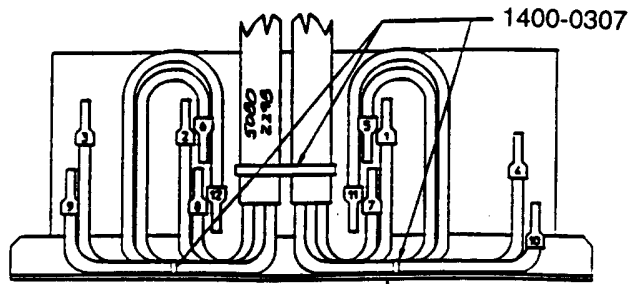
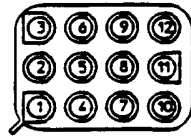

FIGURE 1

EXT	COLOR	EXT	COLOR
1	WHT/GRY	7	VID
2	BRN	8	ORNG
3	WHT/BLK	9	RED
4	WHT	10	WHT/RED
5	BLU	11	GRY
6	BLK	12	WHT/ORNG

TABLE 1



END VIEW OF CONNECTOR
SCALE: 2X

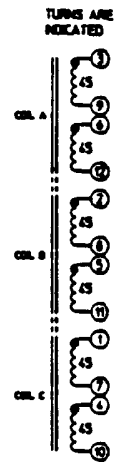

Nut 0535-0023
Lockwasher 2190-0586
Flatwasher 3050-1053

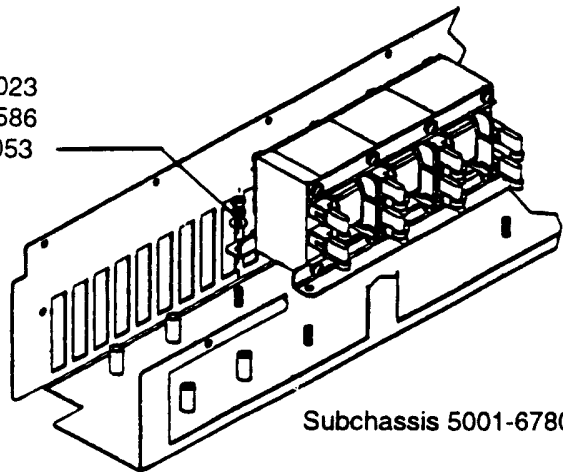

Subchassis 5001-6780

Figure 3-24. Three-Phase Line Choke Subchassis Wiring

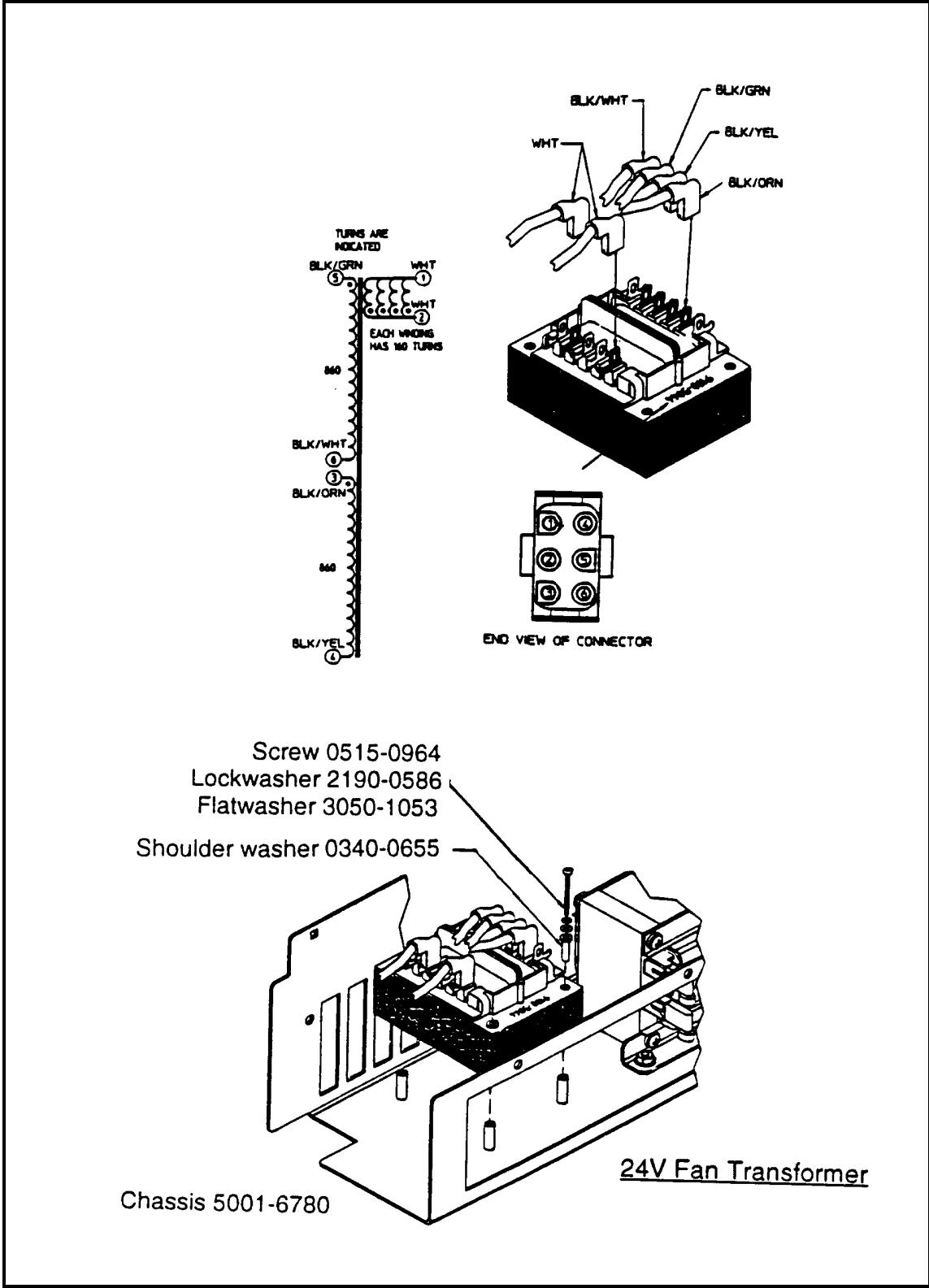

Figure 3-25. 24 Volt Fan Transformer

Principles Of Operation

Introduction

Figure 4-3 (at the end of this chapter) is a block diagram showing the major circuits within the power supply. The power supply consists of the following circuits:

- A1 Front Panel Board ckts.
- A2 GPIB ckts.
- A10 Control Board including the secondary interface ckts, CV/CC control ckts, switching/downprogramming control ckts.
- Power circuits on the A4 AC Input Board.
- A3 FET Assembly ckts.
- A5 DC Rail Board ckts.
- Output bus circuits which include the A7 Snubber Board, A8 Slow Sense Board, and A9 Downprogrammer Board ckts.
- Output rectifiers and filter capacitors.
- Ferrite cores mounted on the output bus form the output filter inductors.
- A6 Bias Board supply which supplies low-voltage, low-power, bias voltages where required.

Each block in Figure 4-3 identifies a schematic diagram in Chapter 6 where the circuits are shown in detail. You can refer to the component location diagrams in Chapter 6 to locate specific components mentioned in this description. Chapter 6 also has a cabling diagram showing the circuit board interconnections.

A2 GPIB Board

Circuits on the A2 GPIB board provide the interface between the GPIB controller and the power supply. All communications between the power supply and the GPIB controller are processed by the GPIB interface and primary microprocessor circuits on the A2 board.

The primary microprocessor circuits (microprocessor, U114, ROM U106, and RAM U108) decode and execute all instructions and control all data transfers between the GPIB controller and the Secondary Interface on the A10 Control Board. The primary microprocessor also processes measurement and status data received from the Secondary Interface.

A UART (universal asynchronous receive/transmit) IC (U112) on the A2 board converts data between the primary microprocessor's 8-bit, parallel bus and the serial I/O port. The serial data is transferred between the primary interface and the secondary interface via a programmed GAL (gated array logic) IC (U119) and optical isolator ICs (U110/U111). These ICs isolate the primary interface circuits (referenced to earth ground) from the secondary interface circuits (referenced to power supply common). The GAL IC also provides a serial I/O port to the A1 Front Panel Board to enable front panel control of the power supply.

A serial link interface IC (U109) on the A2 GPIB Board allows up to sixteen supplies to be connected together and programmed from one GPIB address. The first supply is the only supply connected directly to the GPIB controller and is set to the primary GPIB address. The remaining supplies are set to secondary addresses and are linked (daisy chained) together via the J1/J2 phone jacks at the rear of each supply. The serial link configuration is described in the Power Supply Operating Manual.

A digital control interface on the A2 GPIB Board provides the following power supply functions:

- Relay link.
- Digital I/O.
- Remote inhibit (INH).
- Discrete fault indicator (FLT).

An optical isolator IC (U113) isolates the FLT output signal common from the external fault circuit common. The desired digital interface function is selected by placing a jumper in a header (J106) on the A2 GPIB Board. Appendix D in the Power Supply Operating Manual describes how to select one of these functions and how to make the appropriate external connections to the DIG CNTL connector on the supply's rear panel. Another jumper position on the header selects the SA (signature analysis) mode, which is used for troubleshooting (see Chapter 3).

The A2 Board has a bias supply regulator IC (U121) that provides +5V (with respect to earth ground) for the primary interface circuits and the bias voltage for the front panel board circuits, the LCD, and the keypad. The A2 Board also has a line or bias voltage detector IC (U101) that generates a power clear signal (PCLR). This signal initializes certain primary interface and front panel circuits when normal ac line voltage is applied, and also shuts these circuits down when the line voltage drops below the required minimum.

A1 Front Panel Assembly

The power supply A1 Front Panel Assembly contains a circuit board, keypad, liquid crystal display (LCD), and the power on/off switch.

The Front Panel Circuit Board A1 contains microprocessor circuits (microprocessor U3 and ROM U4) that decode and execute all front panel keypad commands. These are transferred to the power supply output via the serial I/O port to the A2 board GAL (gated-array logic) IC and isolators, and to the secondary interface circuits on the A10 Control Board. The front panel microprocessor circuits also process power supply measurement and status data received from the serial I/O port. This data is displayed on the LCD.

IC EEPROM, U6, (electrically-erasable, programmable, read-only memory) on the A1 Front Panel Board stores data and configuration information. This information includes calibration constants, GPIB address, the present programming language, and model-dependent data such as the minimum and maximum values of voltage and current.

One of the EEPROM storage locations holds a checksum value used to verify the integrity of this EEPROM data. Access to the calibration data in the EEPROM is controlled by the combination of a password and jumper options on a header (J3) located on the A1 board (see Post-Repair Calibration in Chapter 3).

The power supply can be calibrated manually using the front panel keys, or via the GPIB bus with SCPI (Standard Commands for Programmable Instruments) commands. The calibration procedure is in Appendix A of the Power Supply Operating Manual).

A10 Control Board

The A10 Control Board contains the Secondary Interface, CV/CC Control Circuits, Readback Circuits, PWM Switching Circuits and OV/Downprogramming Circuits. These circuits are shown schematically in the A10 Control Board schematic.

Secondary Interface (P/O A10 Board)

These circuits are shown in detail on the A10 Control Board schematic and include the Secondary Microprocessor (U506), Programmed GAL (U505), three DAC/OpAmp circuits (U510-U515), Readback Comparator circuits (U516, U517) and OV/Shunt DAC OpAmp circuit, (U520, U521).

The Secondary Microprocessor translates serial data received from the A2 board into parallel 12 bit data. The data bus is connected directly to the four DAC/OpAmp circuits. Under control of the lip the selected DAC converts the bus data into an analog signal. The DAC reference circuit (U503, U504) provides a +10V reference for the CV and CC DACs and a -11.6V reference for the readback DAC. Zener VR501 provides a -6.2V reference for the OV Shunt DAC.

The CV DAC/OpAmp (U510, U513) converts the programmed voltage value from the bus or front panel into the CVPROG signal. CVPROG is sent to the CV Error Amp and compared with the VMON signal to control the magnitude of the output voltage in the CV mode. The range of CVPROG is 0 volts to -10 volts, which corresponds to the zero-to-full-scale output voltage range of the supply.

The CC DAC/OpAmp (U511, U514) converts the programmed current value from the bus or front panel into the CCPROG signal. CCPROG is sent to the CC Error Amp and is compared with the IMON signal to control the magnitude of the output current in the CC mode. The range of CCPROG is 0 volts to -10 volts, which corresponds to the zero-to-full-scale output current range of the supply.

The Readback Comparators (U516, U517) operate with the Readback DAC/OpAmp (U512, U515) to return the following signals to the μ P:

- The monitored output voltage (VMON).
- The monitored output current (IMON).
- The ambient temperature (AMB_SENSE).
- The programmed voltage value (CVPROG).
- The programmed current value (CCPROG).
- The fan detector (FAN_DEW).

The readback DAC circuit is controlled by the μ P to successively approximate (to 12-bit resolution) the value of each signal monitored. The CVPROG and CCPROG signals are used during selftest to check DAC/OpAmp operation. The μ P monitors the fan speed and ambient temperature and generates the FAN_PWM control signal to adjust fan speed depending upon the ambient temperature measured internally in the power supply.

A dual DAC, Shunt-Trim/OV, Amplifier circuit (U520, U521) performs two functions. One is to convert the programmed overvoltage value from the bus or front panel into the OVREF signal. The OVREF signal is compared by U502 with the output voltage. Second, the Shunt Trim DAC calibrates the IMON signal by sampling the current flowing through current-sense resistor (R900) on the output power bus together with the TRIM input signal.

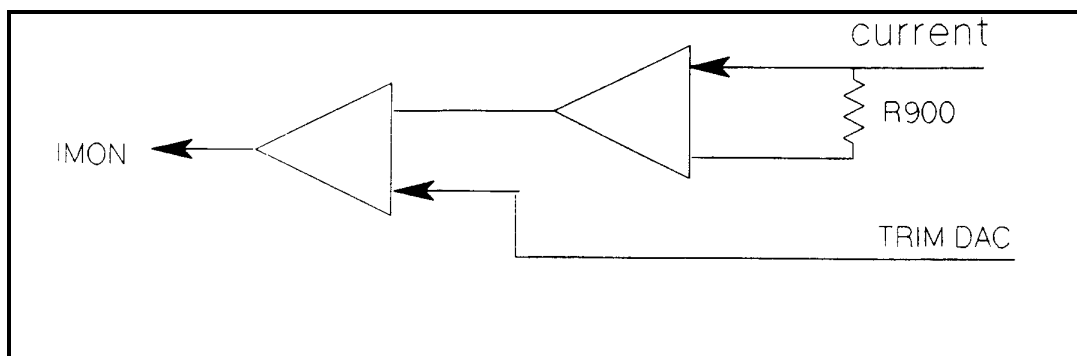

Figure 4-1. AC Calibration of IMON

During power initiation, the secondary processor generates PWM DISABLE to the power supply's output off for 10 seconds. After 10 seconds PWM DISABLE is removed and the supply's output can be programmed.

CV/CC Control (P/O A10 Board) These circuits are shown in detail on the A10 Control Board schematic and include the CV (constant voltage) and CC (constant current) control loops. The power supply must act as either a CV or CC supply for

any value of load impedance. Switching between CV and CC is done automatically by the CV/CC control circuits at a value of load impedance equal to the ratio of the programmed voltage value to the programmed current value.

A low-level CV or CC signal is generated by the applicable status comparator (P/O U502) and returned to the secondary processor to indicate that the corresponding mode, CV or CC, is in effect.

In CV mode, an OR gate diode (D652) conducts and the CV loop regulates the output voltage. A CV error amplifier (P/O U621) compares the programmed voltage signal CVPROG to VMON which is the output signal from the V_DIF amplifier (P/O U621). The range of VMON is 0 volts to +10 volts which corresponds to the zero-to-full-scale output voltage of the supply. If the output voltage exceeds the programmed voltage the OR GATE signal goes low causing the output voltage to decrease to the programmed value.

Conversely, if the output voltage is less than the programmed voltage, the OR GATE signal goes high causing the output voltage to increase to the programmed value. An externally applied dc signal, VPROG, can be used to program the output voltage. A 0 volt to -5 volt VP level produces a proportional zero-to-full-scale output voltage.

In CC mode, an OR gate diode (D651) conducts and the CC loop regulates the output voltage. A CC error amplifier (P/O U620) compares the programmed voltage signal CCPROG to IMON which is the output signal of 2nd I_AMP (P/O U620). The range of IMON is 0 volts to +10 volts which corresponds to the zero-to-full-scale output voltage of the supply. If the output current exceeds the programmed current, the OR GATE signal goes low causing the output current to decrease to the programmed value.

Conversely, if the output current is less than the programmed current, the OR GATE signal goes high causing the output current to increase to the programmed value. An externally applied dc signal, IPROG, can be used to program the output current. A 0 volt to -5 volt IP level produces a proportional zero-to-full-scale output current.

Switching/Downprogramming Control (P/O A10) These circuits include a Ramp Generator, Divider /Deadtime Latch, Fast Sense Differential Amplifier, Pulse Width Modulator, Summing Comparator, Down-Programmer Control and OV Comparator circuits.

The Divider/Deadtime Latch (U600, U601, U602) divides the 2-MHz ALE_CK signal from the Secondary μ P and supplies 40 KHz pulses to the Ramp Generator (U607) and ON Latch (U604).

The OR-GATE signal (CV or CC control signal as previously described) is summed with the 40 KHz triangular waveform produced by the Ramp Generator. An input from the Fast Sense Differential Amplifier is also summed to compensate for a sudden transient in the rectified output.

The width of the output pulses from the Summing Amplifier vary as the OR-GATE control signal increases or decreases. These pulses are applied to the Pulse-Width Modulator (U603) via the On Latch. The PWM generates the square wave pulses that are applied to the A3 FET assembly to turn the FET switches on and off. The Deadtime Latch resets the ON Latch to provide a minimum off time for the FET switches.

The OV circuit compares the output voltage level with the OVREF signal which represents the programmed overvoltage level. When the output voltage exceeds the programmed OV value, the downprogrammer circuits are activated and the FET switches are turned off.

The Downprogrammer control circuit generates control signal DP CONTROL whenever an OV or disable condition has been detected, or when the output voltage exceeds the programmed value. DP CONTROL causes the downprogrammer FETs (Q980, Q981) on the A9 Downprogrammer/Fast Sense board to conduct and conduct current away from the load.

A4 AC Input Board

The A4 Input Board contains the Inrush-Current Limit relay (K401), Main Power Relay (K402), current-limiting resistors (R407, R408) and open-fuse-detect resistor circuit (R400-R405). On power-on, the current-limit relay (K401) closes allowing the dc rail capacitors to charge under a controlled condition. This applies ac voltage to the A6 Bias Board. After the turn-on initialization period (approximately 10 seconds), the main relay (K402) closes, shorting out the current-limit resistor.

The open-fuse resistors supply partial ac voltage to the front panel LED board. An open-fuse causes an unbalanced voltage to be supplied to the open-fuse detect circuit causing the front panel **Check Fuses** LED to flash. If all three fuses are good, or if all three are open, the **Check Fuse** does not flash. The three-phase line inductor is connected to the A4 Input board via J417 (Range 1, 180-235Vac) or J418 (Range 2, 360-440Vac).

A5 DC Rail Board

The A5 DC Rail board contains the full-wave, three-phase, rectifiers and the input filter circuits. The ac mains are full-wave rectified by D420-D425 and converted to two, 300-volt dc rails by filter capacitors, C423-C426, and by two range select connectors. In range 1 (180-235Vac), J438 connects the two DC rails, called Rail #1 and Rail #2, in parallel. Each rail supplies 300Vdc to the A3 FET board via J430 and J431. In Range 2 (360-440Vac), J439 connects the two DC rails in series. Each rail still supplies 300 Vdc to the A3 FET board via J430 and J431.

The A5 DC Rail board also contains the bias transformer and primary range select connectors J436 (Range 1) and J437 (Range 2). There are two LEDS (DS420, DS421) which light when more than 40Vdc is present on the dc rails.

WARNING

As a precaution always disconnect power supply from ac mains and wait 7 minutes before handling dc rail board. Be certain that the LEDs are completely extinguished.

The +24 auxiliary bias fuse, F420, and the standard bias fuse, F421, are located on the dc rail board.

A3 FET Board

The A3 FET board consists of two power FET stages connected between the +rail and -rail voltages, and connected across the FET stages is a chassis mounted power transformer. The entire circuit represents an H-bridge configuration. A complete stage consists of eight, power FETs and two, bridge-driver ICs. The power FETs are mounted on but isolated from the heat sink assembly. The two power FET stages are isolated from each other.

The DRIVE1A, 1B and DRIVE2A, 2B pulses, received from the A10 Control board, are used by the bridge drivers (U201, U202, U301, U302) to derive control pulses for the FET switches. The width of the pulses determines the ON time of the FET switches, thereby determining the magnitude of the output voltage or current. DRIVE1A pulses turn on one set of +RAIL (Q301, Q311) and -RAIL (Q303, Q333) FETs, causing current to flow through power transformer, T900, in one direction. DRIVE2A pulses turn on the other set of +RAIL (Q304, Q344) and -RAIL (Q302, Q322) FETs causing current to flow through T900 in the opposite direction. The FET on/off periods are controlled by the duty-cycle detect and the peak-current detection circuits. If the output attempts to change, regulation is accomplished by the CV/CC control circuits on the A10 Control board. These circuits vary the width of the drive pulses and the duration of the FET on/off periods.

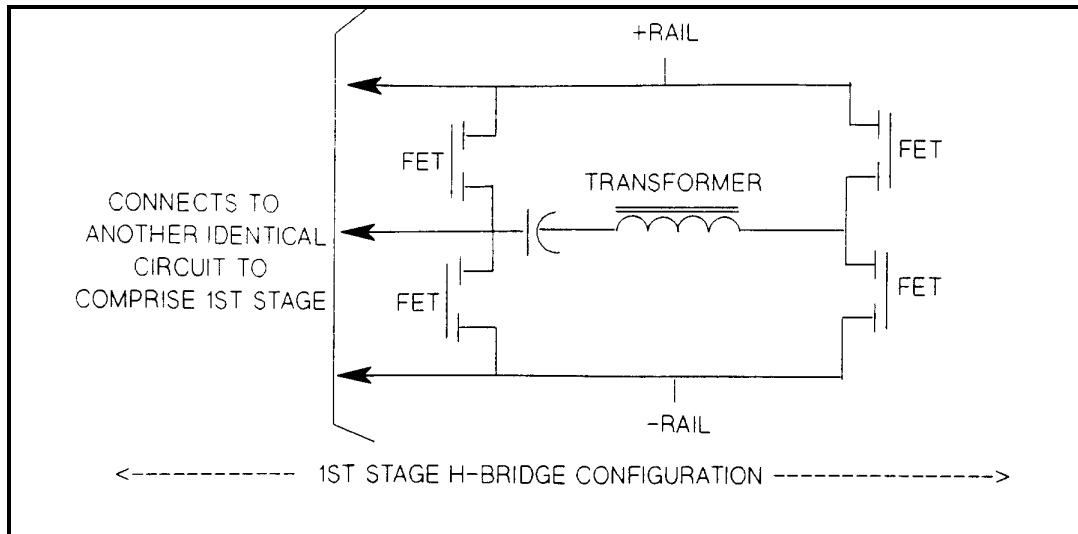

Figure 4-2. 1ST Stage of the FET H-Bridge Configuration

Output Circuits

The output circuits include the following circuits:

- Chassis mounted components.
- Two power transformers, T900/T901.
- Two inductors, L900/L901.
- Four rectifiers, D900 through D903.
- Output capacitors.
- A7 Snubber board mounted to the heat sink.
- A8 Fast Sense board.
- A9 Slow/Downprogrammer board and output bus bars.

Each combination of power transformers, T900/T901, and rectifiers, D900/D903, couples the output pulses from the A3 FET board. The output of each transformer/rectifier combination is connected in parallel before being applied to the output filter. The output filter assembly consists of bus bars with the filter capacitors bolted to them. The filter chokes, L902 through L906, consist of ferrite cores enclosing the bus bar. The current-sense resistor, R900, is part of the positive-output bus bar.

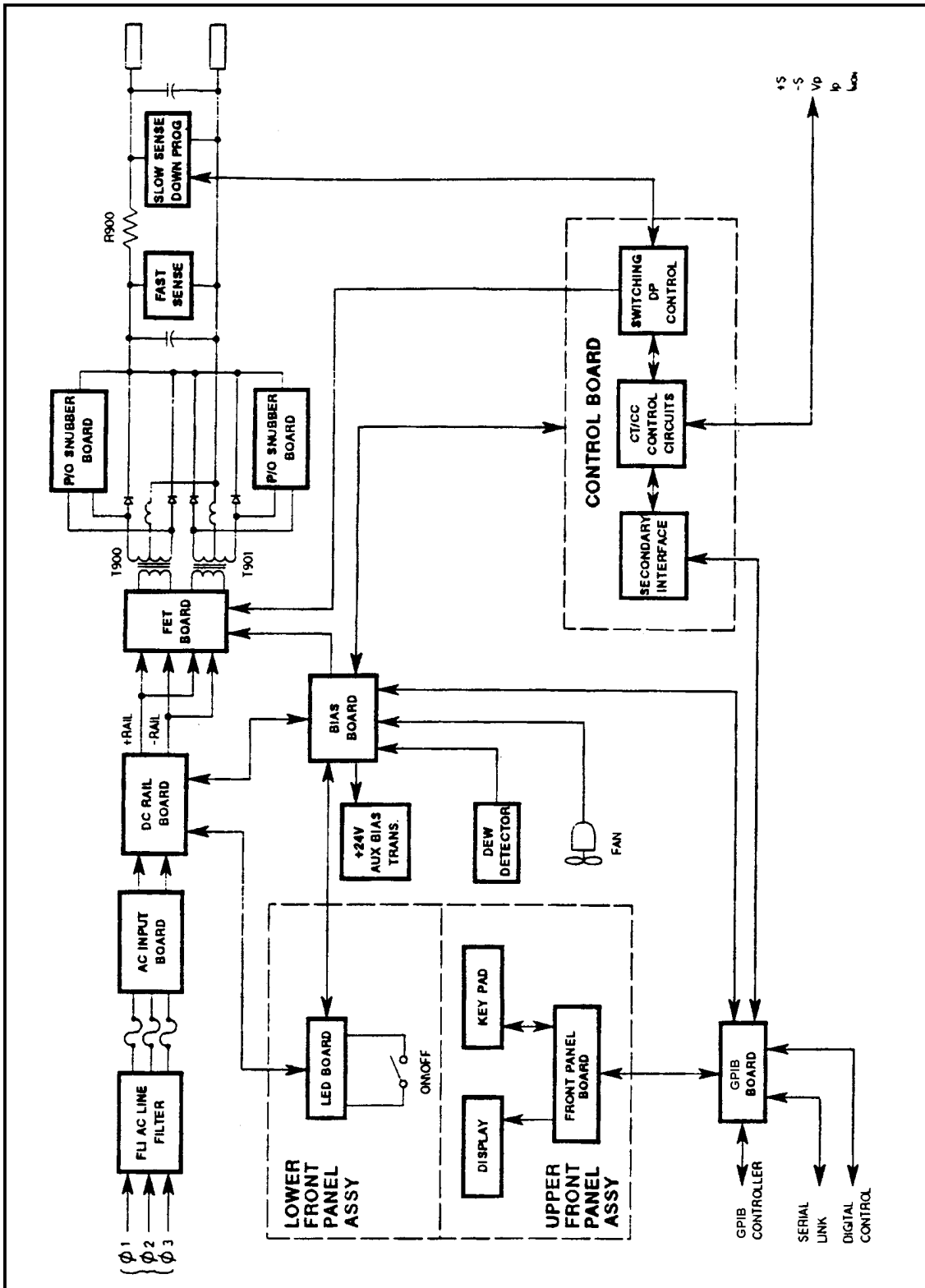

Figure 4-3. Agilent Series 668xA Power Supply, Block Diagram

Replaceable Parts

INTRODUCTION

Chapter Organization

This section lists the replaceable electrical and mechanical parts for the Agilent 668xA series power supplies. (Component location diagrams are located in Chapter 6.) The lists consist of tables organized by assemblies as follows:

Assembly	See
Main chassis *	Table 5-3
A1 Front Panel EBoard	Table 5-4
LED Board	Table 5-5
A2 GPIB Board	Table 5-6
A3 FET Board	Table 5-7
A4 AC Input Board	Table 5-8
A5 DC Rail Board	Table 5-9
A6 Bias Board	Table 5-9
A7 Snubber Board	Table 5-11
A8 Fast Sense Board	Table 5-9
A9 Down Programming/Slow Sense Board	Table 5-9
A10 Control Board	Table 5-10

* The locations of circuit board assemblies and chassis-mounted components are shown in Fig 3-20.

Reading the Tables

Each table lists electrical components alphabetically by reference designator and provides the Agilent part number followed by the part description. Mechanical parts are placed after the electrical parts and listed alphabetically by part description. Unless otherwise specified, a listed part is used in all models of the series. Model-specific parts are tabulated by model number under the reference designator. The reference designators are defined in Table 5-1. Abbreviations used in parts descriptions are explained in Table 5-2.

Table 5-1. Part Reference Designators

A	assembly	J	jack	SW	switch
B	blower (fan)	K	relay	T	transformer
C	capacitor	L	inductor	TB	terminal block
CR	thyristor/SCR	P	plug	U	integrated circuit
D	diode	Q	transistor	VR	voltage regulator
DSP	display (LCD)	R	resistor	W	cable or jumper
F	fuse	RT	thermal resistor	Y	crystal oscillator

Table 5-2. Part Description Abbreviations

assy	assembly	M	metric	sq	square	w/o	without
bd	board	mch	machine	submin	subminiature	xfmr	transformer
blvl	belleville	mm	millimeter	thk	thick	xtal	crystal
gnd	ground	mtg	mounting	thrd	thread		
lg	long	PCB	pc board	w/	with		

How to Order Parts

You can order parts from your local Agilent Technologies, Inc. Sales and Support Office (see the list of offices in the back of this manual). When ordering a part, please include the following information:

- the Agilent part number
- the desired quantity
- the part description
- the model number of the power supply (for example, Agilent 6682A)

Table 5-3. Main Chassis, Replaceable Parts

Ref. Desig.	Agilent Part No.	Description
ASSEMBLIES & SUBASSEMBLIES		
A1	5060-3553	TESTED FRONT PANEL/KEYPAD
	5060-3542	TESTED KEYPAD PCB ASSY.
A2	5060-3591	TESTED GPIB PC ASSY.
A3	5060-3540	TESTED FET ASSY.
A4	5060-3543	TESTED AC INPUT BOARD ASSY.
A5	5060-3544	TESTED DC RAIL BOARD ASSY.
A6	5060-3541	TESTED BIAS PC ASSY.
A7		
6680A	06680-60021	SNUBBER PCB ASSY.
6681A	06681-60021	SNUBBER PCB ASSY.
6682A	06682-60021	SNUBBER PCB ASSY.
6683A	06683-60021	SNUBBER PCB ASSY.
6684A	06684-60021	SNUBBER PCB ASSY.
A8		FAST SENSE PCB
A9		
6680A	06680-60022	DOWN PROGRAMMER / SLOW SENSE PC
6681A	06681-60022	DOWN PROGRAMMER / SLOW SENSE PC
6682A	06682-60022	DOWN PROGRAMMER / SLOW SENSE PC
6683A	06683-60022	DOWN PROGRAMMER / SLOW SENSE PC
6684A	06684-60022	DOWN PROGRAMMER / SLOW SENSE PC
A10		
6680A	06681-61020	TESTED CONTROL PCB ASSY.
6681A	06681-61020	TESTED CONTROL PCB ASSY.
6682A	06682-61020	TESTED CONTROL PCB ASSY.
6683A	06683-61020	TESTED CONTROL PCB ASSY.
6684A	06684-61020	TESTED CONTROL PCB ASSY.
ELECTRICAL PARTS		
C423, 424, 425, 426	0180-4369	C-F 1500uF 400V
C900		
6680A	0180-4516	CAP 33000uF 7.5V
6681A	0180-4532	CAP 22000uF 16V
6682A	0180-4615	CAP 18000uF 28V
C901, 902, 903, 904, 905		
6680A	0180-4516	CAP 33000uF 7.5V
6681A	0180-4532	CAP 22000uF 16V
6682A	0180-4615	CAP 18000uF 28V
6683A	0180-4596	CAP 13000uF 45V
6684A	0180-4597	CAP 7.200uF 55V
C906		
6680A	0180-4516	CAP 33000uF 7.5V
6681A	0180-4532	CAP 22000uF 16V

Table 5-3. Main Chassis, Replaceable Parts

Ref. Desig.	Agilent Part No.	Description
C907		
6680A	0180-4516	CAP 33000uF 7.5V
6681A	0180-4532	CAP 22000uF 16V
6682A	0180-4615	CAP 18000uF 28V
6683A	0180-4596	CAP 13000uF 45V
6684A	0180-4597	CAP 7.200uF 55V
C920, 921,922,923,924,925		
6682A, 6683A, 6684A	0160-4183	CAP 1000pF 250V
D900		
6680A, 6681A	1906-0396	SHOTTY RECTIFIER
D900A,B		
6682A	1906-0397	SHOTTY RECTIFIER
6683A, 6684A	1906-0398	SHOTTY RECTIFIER
D901		
6680A, 6681A	1906-0396	SHOTTY RECTIFIER
D901A,B		
6682A	1906-0397	SHOTTY RECTIFIER
6683A, 6684A	1906-0398	SHOTTY RECTIFIER
D902, 903		
6680A, 6681A	1906-0396	SHOTTY RECTIFIER
L900, 901		
6680A, 6681A	06681-80001	CHOKE - OUTPUT
6682A	06681-80004	CHOKE - OUTPUT
6683A	06681-80005	CHOKE - OUTPUT
6684A	06681-80006	CHOKE - OUTPUT
L902, 903	5080-2257	CORE
L904, 905, 906	9170-1571	CORE
Q981, 982	1855-0834	POWER MOSFET
R900		
6680A	5080-2296	SHUNT-CURRENT
6681A	5080-2297	SHUNT-CURRENT
6682A	06682-80002	SHUNT-CURRENT
6683A	5080-2324	SHUNT-CURRENT
6684A	5080-2324	SHUNT-CURRENT
T900, 901		
6680A	9100-5042	POWER TRANSFORMER
6681A	9100-5043	POWER TRANSFORMER
6682A	9100-5086	POWER TRANSFORMER
6683A	9100-5085	POWER TRANSFORMER
6684A	9100-5076	POWER TRANSFORMER
MECHANICAL PARTS		
	06652-00005	BUS BAR
	06680-20001	BUSS BAR BLOCK
	06680-20002	BUSS/FET BLOCK
	06680-80003	NAMEPLATE front panel model description
	06681-80003	NAMEPLATE front panel model description
	06682-80001	NAMEPLATE front panel model description
	06683-80001	NAMEPLATE front panel model description
	06684-80001	NAMEPLATE front panel model description
	0960-0882	SENSOR-MOISTURE
	1252-1488	TERM-BLK-4 POS
	1252-3698	CONNECTOR

Table 5-3. Main Chassis, Replaceable Parts (continued)

Ref. Desig.	Agilent Part No.	Description
	2110-0910	FUSE (see 5060-3513)
	2110-0911	FUSE (see 5060-3512)
	3160-0419	FAN FINGER GUARD
	3160-0571	FAN-TUBEAXIAL
	5001-0538	TRIM-SIDES
	5001-0539	TRIM SIDES,FRENCH GRAY
	5001-6776	CHASSIS, BASE
	5001-6778	PANEL, REAR
	5001-6779	COVER-OUTSIDE
	5001-6780	INPUT SUB-CHASSIS (see 5060-3490)
	5001-6781	OUTPUT SUB-CHASSIS
	5001-6782	CHASSIS-TOP (inside cover)
	5001-6783	INPUT DECK
	5001-6784	OUTPUT DECK
	5001-6791	TRAY (control board)
	5001-6792	SHIELD
	5001-6793	GPIB-BRACKET (chassis top)
	5020-2783	HEATSINK-DIODE
	5020-2785	HEATSINK-FET
	5020-2797	SHIELD-ISOLATION
	5020-2808	INSULATOR
	5040-1688	BUSS-BEZEL
	5040-1689	BUSS BAR SUPPORT
	5040-1690	BRACKET-HS
	5040-1691	HS-PLEN
	5040-1694	BUSS BAR, PLUS, output end (large)
	5040-1696	BUSS BAR, PLUS, internal end (small)
	5040-1697	BLOCK-TOP COVER
	5040-1700	COLLAR-MOLDED
	5040-1701	BUSS BAR BRACE
	5041-880 1	FOOT
	5041-8819	CAP-STRAP HANDLE
	5041-8820	CAP-STRAP HANDLE
	5060-3237	AC INPUT COVER ASSY.
	5060-3490	AC SUB-CHASSIS ASSY.
	5060-3489	NEGATIVE OUTPUT BUSS BAR ASSY. with L902/L903 CORE
	5001-6780	SUB-CHASSIS
	5080-2262	3 PHASE LINE CHOKE
	5080-2298	CABLE - 3 phase line choke/AC input assy
	9100-5044	FAN TRANSFORMER
	5060-3492	WIRE KIT (+/- sense leads)
	5060-3512	400VAC/16A FUSE KIT
	2110-0911	3 ea. FUSE 16AM 400VAC
	5060-3513	208VAC/30A FUSE KIT
	2110-0910	3 ea. FUSE 30AM 500V
	5062-3705	STRAP HANDLE
	5080-2038	LABEL-WARNING (no operator serviceable)
	5080-2148	CABLE (chaining- 2 meters)
	5080-2168	CABLE-ASSY.
	5080-2277	SUL-THERMAL
	5080-2280	CABLE- BIAS/CONTROL
	5080-2282	CABLE - AC/RFI FILTER
	5080-2285	CABLE- GPIB/FAN

Table 5-3. Main Chassis, Replaceable Parts (continued)

Ref. Desig.	Agilent Part No.	Description
	1400-0611	CABLE CLAMP (GPIB/FAN)
	5080-2299	LABEL REAR PANEL
	5080-2413	CRATE (shipping container)
	5080-2414	SKID (shipping container)
	5080-2415	FOAM PAD (shipping container)
	5080-2314	EDGE PROTECTOR 12 inches (shipping container)
	5080-2315	EDGE PROTECTOR 2.5 inches (shipping container)
	5080-2316	CABLE ASSY.
	5960-5588	MANUAL-OPERATING
	6681A#400	400V OPERATION
	6681A#601	BUS BAR COVER
	6681A#602	BUS BAR SPACER
	5060-3514	BB SPCR KIT #602
	6681A#861	CABLE-UL/CSA
	8120-6203	L CORD 10AWG300V
	6681A#862	CABLE-HARMONIZED
	8120-6204	L CORD 2.5mm450V
	6681A#908	RACK MOUNT KIT
	5062-3974	RACK MTG KIT
	5062-3977	RACK MOUNT KIT
	6681A#909	RACK MOUNT KIT W/HANDLES
	5062-3974	RACK MTG KIT
	5062-3983	RACK MOUNT KIT
	7120-6153	LABEL-WARNG
	9135-0493	FILTER-RFI

Table 5-4. A1 Front Panel Board, Replaceable Parts

Ref. Desig.	Agilent Part No.	Description
ELECTRICAL PARTS		
C1	0160-5422	Capacitor 0.047 μ F 20%
C2	0160-4808	Capacitor 470pF 5%
C4	0160-4787	Capacitor 22pF 5% 100V
C5	0180-0155	Capacitor 2.2 μ F 20V
C6,7	0160-5422	Capacitor 0.047 μ F 20%
C8	0160-4835	Capacitor 0.1 μ F 10% 50V
C10-12, C14-16	0160-5422	Capacitor 0.047 μ F 20%
C17	0180-0155	Capacitor 2.2 μ F 20V
D1,2	1906-0229	Diode array 50V
L1	9140-0158	COIL IUH 10%
J2	1251-4927	Receptacle LCD display
J3	1251-4926	Receptacle test header
J4,5	1252-0718	Receptacle (A3G1, A3G2)
J6	1251-8184	Receptacle phone (GPIB board)
L1	9140-0158	Inductor 1 μ H 10%
R1	1810-0560	Resistor network DIP
R2	0698-3359	Resistor 12.7K 1%
R23-25,27-30	0698-3155	Resistor 4.64K 1%
R37	1810-0371	Resistor network SIP
R38	0698-3441	Resistor 215 Ω 1% 0.125W
R39,40	0698-3155	Resistor 4.64K 1%
RT1	0837-0412	Thermistor

Table 5-4. A1 Front Panel Board, Replaceable Parts (continued)

Ref. Desig.	Agilent Part No.	Description
S1	3101-3088	Line switch
VR16	1902-0950	Diode Zener 4.7V 5
U3	1820-6721	IC MPU
U4	5080-2466	ROM programmed front panel
U6	1818-4792	IC memory
U8	1820-2724	IC SN74ALS573BN
W3	1258-0209	Jumper (J3)
W5	0811-3590	Jumper
Y1	0410-2159	Crystal 10 MHz
Z16	1902-0950	Diode Zener 4.7V 5%
MECHANICAL PARTS		
--	1200-1274	Socket IC (U3)
--	1200-1417	Socket IC (U4)
--	0340-1277	Insulator (Y1)
--	0370-3238	KNOB Ref: RPG
--	0515-1455	SCREW - Ref: keypad PCB to front frame
--	0590-0534	NUT - SELFTREAD - Ref: Display & LED board to front panel
--	0960-0912	RPG - OPTICAL ENCODER
--	5063-3408	PCA (KEYPAD)
--	1000-0842	WINDOW Ref: 3 inches front frame
--	5001-6794	BLINDER Ref: 5 inches front frame
--	5040-1665	KEYPAD
--	5040-1687	FRONT FRAME - 88.1mm (3.5 inches)
--	5040-1698	FRONT FRAME - 132.6mm (5.25 inches)
--	5063-3473	LCD DISPLAY
--	5080-2245	LABEL Ref: 3.5 inches & 5 inches front frame
--	5080-2261	CABLE Ref: Keypad PCB to LCD display

Table 5-5. Front Panel Board LED Assy, Replaceable Parts

Ref. Desig.	Agilent Part No.	Description
ELECTRICAL PARTS		
C450	0180-4132	CAP 6.8uF 35V
C451	0160-4808	CAP 470pF 5%
D450, 451, 452, 453	1901-1098	DIO-1N4150
R450	0698-3444	RES 316 1% .125W
R451	0757-0401	RES 100 1% .125W
R452	0698-3156	RES 14.7K 1%
R453	0698-8827	RES 1M 1% .125W
R454	0698-3156	RES 14 7K 1%
R455	0757-0280	RES 1K 1% .125W
U450	1858-0076	XSTR ARY 14P-DIP
U451	1858-0077	XSTR ARY 14P DIP
Z450	1902-0562	DIO-ZNR 22.1V 5%
MECHANICAL PARTS		
	5080-2281	CABLE LINE SWITCH Ref: E456=E457 to S1
	5080-2283	CABLE LED AC INPUT Ref: E450-E451 to DC RAIL J440
	5080-2286	CABLE DEW/S1 CONNECTION Ref: E452-E455 to DC RAIL J441

Table 5-6. A2 GPIB Board, Replaceable Parts (see Note)

Ref. Desig.	Agilent Part No.	Description
ELECTRICAL PARTS		
C122	0180-4606	Capacitor 10,000 μ F
C128	0160-4281	Capacitor 2,200pF
F101	2110-0699	Fuse Subminiature 5AM
J101	1252-2320	Connector Receptacle (GPIB)
J106	1251-4926	Connector Receptacle (Test Header)
J107, 108, 114, 115	1251-7330	Connector Receptacle
P101	1251-4245	Connector Plug 2-pin (AC Bias)
U110, U111	1990-0444	IC Optoisolator
U113	1990-0543	IC Optoisolator
U117	1820-2549	IC Optoisolator
U118	1820-4185	IC Optoisolator
U121	1820-0430	IC Voltage regulator
TB101	0360-2312	Terminal Block (Digital Control)
MECHANICAL PARTS		
--	1205-0758	Heatsink (U121)
--	0535-0031	Nut hex w/lockwasher (J101)
--	0515-0642	Screw (U121)
--	0515-0911	Screw M3x0 5 (J101)
Note: All other parts are surface mounted and are not field repairable		

Table 5-7. A3 FET Assembly, Replaceable Parts

Ref. Desig.	Agilent Part No.	Description
ELECTRICAL PARTS		
C201	0160-7505	7 μ F+ - 5% 200V
C202	0180-4132	CAP 6.8 μ F 35V
C203	0160-4835	CAP .1 μ F 10% 50V
C204, 205	0160-5098	CAP .22 μ F 10%
C206	0180-4132	CAP 6.8 μ F 35V
C207, 208, 209	0160-2006	CAP 100pF 10%
C210, 211, 213, 214,	0160-6838	CAP 2200pF 1KV
C215, 216	0160-2006	CAP 100pF 10%
C217	0160-5098	CAP .22 μ F 10%
C218	0160-4835	CAP .1 μ F 10% 50V
C219	0160-2006	CAP 100pF 10%
C220	0180-4132	CAP 6.8 μ F 35V
C221	0160-5098	CAP .22 μ F 10%
C222	0180-4132	CAP 6.8 μ F 35V
C226	0160-4791	CAP 10pF 5% 100V
C227	0160-4835	CAP .1 μ F 10% 50V
C228	0160-2301	CAP 2000pF 100V
C229	0160-4918	CAP .022 μ F 50V
C230	0160-4831	CAP 4700pF 10%
C231	0160-2301	CAP 2000pF 100V
C235, 236, 237, 238	0160-4832	CAP .01 μ F 10%
C239	0160-4791	CAP 10pF 5% 100V
C240	0160-4832	CAP .01 μ F 10%
C242, 243	0160-5098	CAP .22 μ F 10%

Table 5-7. A3 FET Assembly, Replaceable Parts (continued)

Ref. Desig.	Agilent Part No.	Description
C244, 245	0160-6806	CAP .1uF 400V
C248	0160-4832	CAP .01uF 10%
C258	0180-4132	CAP 6.8uF 35V
C301	0160-7505	7uF+ - 5% 200V
C302	0180-4132	CAP 6.8uF 35V
C303	0160-4835	CAP .1uF 10% 50V
C304, 305	0160-5098	CAP .22uF 10%
C306	0180-4132	CAP 6.8uF 35V
C307, 308, 309	0160-2006	CAP 100pF 10%
C310, 311, 313, 314	0160-6838	CAP 2200pF 1KV
C315, 316	0160-2006	CAP 100pF 10%
C317	0160-5098	CAP .22uF 10%
C318	0160-4835	CAP .1uF 10% 50V
C319	0160-2006	CAP 100pF 10%
C320	0180-4132	CAP 6.8uF 35V
C321	0160-5098	CAP .22uF 10%
C322	0180-4132	CAP 6.8uF 35V
C326	0160-4791	CAP 10pF 5% 100V
C329	0160-5098	CAP .22uF 10%
C330	0160-4832	CAP .01uF 10%
C331	0160-4835	CAP .1uF 10% 50V
C335, 336, 337, 338	0160-4832	CAP .01uF 10%
C339	0160-4791	CAP 10pF 5% 100V
C340	0160-4832	CAP .01uF 10%
C342, 343	0160-5098	CAP .22uF 10%
C344, 345	0160-6806	CAP .1uF 400V
C346	0160-4800	CAP 120pF 5%
D201, 202	1901-0050	DIO-SWITCHING
D202	1901-1065	DIO-IN4936 PWR
D203, 204	1901-0050	DIO-SWITCHING
D205	1901-1065	DIO-IN4936 PWR
D206, 207, 208, 209, 210	1901-0050	DIO-SWITCHING
D213, 214, 215, 216, 217	1901-0050	DIO-SWITCHING
D220, 221, 222, 223	1901-0050	DIO-SWITCHING
D224	1901-0731	DIO-PWR RECT
D301, 302	1901-0050	DIO-SWITCHING
D302	1901-1065	DIO-IN4936 PWR
D303, 304	1901-0050	DIO-SWITCHING
D305	1901-1065	DIO-IN4936 PWR
D306, 307, 308, 309, 310	1901-0050	DIO-SWITCHING
D313, 314, 315, 316, 317	1901-0050	DIO-SWITCHING
D320, 321, 322, 323	1901-0050	DIO-SWITCHING
D324	1901-0731	DIO-PWR RECT
L201, 202, 203, 204	9170-1454	CORE-SHLD-BEAD
L205, 206, 207, 208, 209	9170-1510	CORE-MAGNETIC
L210, 211, 212	9170-1510	CORE-MAGNETIC
L213, 214, 215, 216	9170-1454	CORE-SHLD-BEAD
L301, 302, 303, 304	9170-1454	CORE-SHLD-BEAD
L305, 306, 307, 308, 309	9170-1510	CORE-MAGNETIC
L310, 311, 312	9170-1510	CORE-MAGNETIC
L313, 314, 315, 316	9170-1454	CORE-SHLD-BEAD
Q201, 202, 203, 204	1855-0859	MOSFET 500V 20A
Q211, 222, 233, 244	1855-0859	MOSFET 500V 20A
Q251, 252, 253, 254	1853-0363	D45H5/D45H8/363

Table 5-7. A3 FET Assembly, Replaceable Parts (continued)

Ref. Desig.	Agilent Part No.	Description
Q301, 302, 303, 304	1855-0859	MOSFET 500V 20A
Q311, 322, 333, 344	1855-0859	MOSFET 500V 20A
Q351, 352, 353, 354	1853-0363	D45H5/D45H8/363
R201	0811-3903	RES 150 Ohm 5W NI
R202	0699-0208	RES 1 5% .25W CF
R203	0683-5615	RES 560 5% .25W
R205	0683-0625	RES 6.2 5% .25W
R206	0683-7505	RES 75 5% .25W
R207	0683-0335	RES 3.3 5% .25W
R208	0683-3305	RES 33 5% .25W
R209	0683-0625	RES 6.2 5% .25W
R210	0683-8205	RES 82 5% .25W
R211, 212	0683-1535	RES 15K 5% .25W
R213, 214, 216, 217	0811-3903	RES 150 Ohm 5W NI
R220, 221	0811-3903	RES 150 Ohm 5W NI
R222	0811-2556	RES 1.25 1% 4W
R224, 225	0811-3903	RES 150 Ohm 5W NI
R226	0683-1535	RES 15K 5% .25W
R227	0698-3159	RES 26.1K 1%
R228	0683-8205	RES 82 5% .25W
R229	0683-0625	RES 6.2 5% .25W
R230	0683-3305	RES 33 5% .25W
R231	0683-7505	RES 75 5% .25W
R232	0683-0335	RES 3.3 5% .25W
R233	0683-0625	RES 6.2 5% .25W
R237	0757-0437	RES 4.75K 1%
R238	0757-0280	RES 1K 1% .125W
R239	0757-0437	RES 4.75K 1%
R240	0757-0280	RES 1K 1% .125W
R241, 242	0757-0437	RES 4.75K 1%
R243	0683-1535	RES 15K 5% .25W
R244	0698-4457	RES 576 1% .125W
R245	0683-1015	RES 100 5% .25W
R246	0683-1555	RES 1.5M 5% .25W
R247	0757-0462	RES 75K 1%
R248	0698-3159	RES 26.1K 1%
R249	0757-0444	RES 13.1K 1%
R250	0698-3572	RES 60.4K 1%
R251	0757-0288	RES 9.09K 1%
R252	0698-3225	RES 1.43K 1%
R253	0698-6533	RES 12.5K 1%
R254	0698-3279	RES 4.99K 1%
R255	0683-1015	RES 100 5% .25W
R256	0698-3432	RES 26.1 1%
R257	0698-3430	RES 21.5 1%
R258	0683-1035	RES 10K 5% .25W
R260, 261	0683-8205	RES 82 5% .25W
R262	0683-1215	RES 120 5% .25W
R263, 264, 265	0683-8205	RES 82 5% .25W
R266	0683-1215	RES 120 5% .25W
R267	0683-8205	RES 82 5% .25W
R268	0698-3572	RES 60.4K 1%
R269	0698-4121	RES 11.3K 1%
R270	0757-0440	RES 7.5K 1%

Table 5-7. A3 FET Assembly, Replaceable Parts (continued)

Ref. Desig.	Agilent Part No.	Description
R271	0757-0200	RES 5.62K 1%
R272	0757-0442	RES 10K 1% .125W
R273, 274, 275	0757-0437	RES 4.75K 1%
R277	0698-3633	RES 3905% 2W MO
R301	0811-3903	RES 150Ohm 5W NI
R302	0699-0208	RES 1 5% .25W CF
R303	0683-5615	RES 5605% .25W
R304	0698-4435	RES 2.49K 1%
R305	0683-0625	RES6.25% .25W
R306	0683-7505	RES 75 5% .25W
R307	0683-0335	RES 3.3 5% .25W
R308	0683-3305	RES 33 5% .25W
R309	0683-0625	RES 6.2 5% .25W
R310	0683-8205	RES 82 5% .25W
R311	0683-1535	RES 15K 5% .25W
R312	0683-1535	RES 15K 5% .25W
R313, 314, 316, 317	0811-3903	RES 150 Ohm 5W NI
R320, 321	0811-3903	RES 150 Ohm 5W NI
R322	0811-2556	RES 1.25 1% 4W
R324, 325	0811-3903	RES 150 Ohm 5W NI
R326	0683-1535	RES 15K 5% .25W
R327	0683-1555	RES 1.5M 5% .25W
R328	0683-8205	RES 82 5% .25W
R329	0683-0625	RES 6.2 5% .25W
R330	0683-3305	RES 33 5% .25W
R331	0683-7505	RES 75 5% .25W
R332	0683-0335	RES 3.3 5% .25W
R333	0683-0625	RES 6.2 5% .25W
R337	0757-0437	RES 4.75K 1%
R338	C757-0280	RES 1K 1% .125W
R339	0757-0437	RES 4.75K 1%
R340	0757-0280	RES 1K 1% .125W
R341, 342	0757-0437	RES 4.75K 1%
R343	0683-1535	RES 15K 5% .25W
R354	0757-0442	RES 10K 1% .125W
R355	0698-3136	RES 17.8K 1%
R356, 357	0757-0382	RES 16.21%
R360, 361	0683-8205	RES 82 5% .25W
R362	0683-1215	RES 120 5% .25W
R363, 364, 365	0683-8205	RES 82 5% .25W
R366	0683-1215	RES 120 5% .25W
R367	0683-8205	RES 82 5% .25W
R368	0698-3572	RES 60.4K 1%
R369	0698-4121	RES 11.3K 1%
R370	0757-0440	RES 7.5K 1%
R371	0757-0200	RES 5.62K 1%
R372	0757-0442	RES 10K 1% .125W
R373, 374, 375	0757-0437	RES 4.75K 1%
R377	0698-3633	RES 390 5% 2W MO
R378	0757-0274	RES 1.21K 1%
R379	0683-1005	RES 10 5% .25W
R380	0757-0437	RES 4.75K 1%
R381	0698-0085	RES 2.61K 1%
R382	0683-1015	RES 100 5% .25W

Table 5-7. A3 FET Assembly, Replaceable Parts (continued)

Ref. Desig.	Agilent Part No.	Description
R383	0757-0442	RES 10K 1% .125W
R384, 385	8159-0005	RES-ZERO OHMS
T202	9100-4350	XFMR-CURRENT
T204	06624-80091	XFMR-PULSE
T205	5080-2238	XFMR-CUR SHARING
T302	9100-4350	XFMR-CURRENT
T304	06624-80091	XFMR-PULSE
U201, 202	1820-8433	PWM I.C. IR2110
U203	1826-1343	IC-VOLTAGE REG TL431CP
U204	1826-0138	IC COMPARATOR LM339N
U205	1826-1475	VOLTAGE COMPTR LT101HCN8
U301, 302	1820-8433	PWM I.C. IR2110
U303	1826-1343	IC-VOLTAGE REG TL431CP
U304	1826-0412	IC LM393N
U305	1990-0996	OPTO-ISOLATOR HCPL-2200
Z201, 301	1902-1377	DIO-ZNR 6 19V
MECHANICAL PARTS		
	5080-2279	CABLE FET CONTROL Ref: E208-E209 to CONTROL J511
	5080-2283	CABLE +15V BIAS Ref: E206-E207 to BIAS J831 Ref: E306-E307 to BIAS J830
	5080-2291	CABLE FET RAIL A Ref: E201-E202 to DCRAIL J430
	5080-2295	CABLE FET RAIL B Ref: E301-E302 to DCRAIL J431

Table 5-8. A4 AC Input Assembly, Replaceable Parts

Ref. Desig.	Agilent Part No.	Description
ELECTRICAL PARTS		
C420	0160-7606	CAP 1uF 275V
C428, 429, 430	0160-7898	CAP 0.01uF 440V
J417, 418	1251-5422	CONNECTOR
J419	1251-6832	CONNECTOR
J420	1251-3819	CONNECTOR
K401	0490-1908	RELAY 24V COIL
K402	5060-3593	CONTACTOR, 3 POLE
R400, 401,402,403,404,405	0764-0027	RES 75K 5% 2W MO
R407, 408	0699-3191	RES 27 OHM 5% 20W
R435, 436, 437	0698-3609	RES 22 OHM 5% 2W
MECHANICAL PARTS		
	5060-3493	WIRE KIT (E403-E408 to F1,F2,F3)
	5080-2284	CABLE RELAY CNTRL (E411-E413 to BIAS J827)

Table 5-9. A5 DC Rail Assembly, Replaceable Parts

Ref. Desig.	Agilent Part No.	Description
ELECTRICAL PARTS		
C418	0160-4048	CAP 0.022uF 20%
C420, 421, 422	0160-7606	CAP 1uF 275V
C427	0160-7743	C-F .047uF 380V
D420, 421, 422, 424, 425	5060-3516	ASSY.-RECTIFIER
DS420, 421	1990-0517	LED
F420	2110-1107	FUSE CLIPS
F420	2110-0934	FUSE .5AM, 500V
F421	2110-1107	FUSE CLIPS
F421	2110-0934	FUSE .5AM, 500V
J430, 431	1251-7616	CONNECTOR
J432	1251-6832	CONNECTOR
J433	1251-3819	CONNECTOR
J436, 437, 438, 439	1251-3837	CONNECTOR
J440	1252-0055	CONNECTOR
J441	1252-0056	CONNECTOR
L420, 421	5080-2300	INDUCTOR-NM
R420, 421, 422	0698-3611	RES 27 5% 2W MO
R423, 424, 425,426,427,428	0764-0044	RES 8.2K 5% 2W
R429, 430, 431,432,433,434	0764-0044	RES 8.2K 5% 2W
MECHANICAL PARTS		
	5080-2286	CABLE BIAS 24V SECONDARY Ref: E440-E443 to BIAS J816
	5080-2288	CABLE AC POWER Ref: E420-E425 to ACINPUT J420
	5080-2289	CABLE AC BIAS Ref: E430-E434 to ACINPUT J419
	5080-2293	CABLE BIAS LINE SELECT Ref: E444-E447 to J436/J437
	5080-2294	CABLE RAIL LINE SELECT Ref: E448-451 to J438/J439

Table 5-10. A6 Bias Assembly, Replaceable Parts

Ref. Desig.	Agilent Part No.	Description
ELECTRICAL PARTS		
C800	0160-4834	CAP .047uF 10%
C801	0180-4140	CAP 1800 uF 63V
C803	0160-5422	CAP .047uF 20%
C804	0180-4131	CAP 4.7uF 35V
C805	0160-7743	C-F .047uF 380V
C806	0160-4834	CAP .047uF 10%
C807	0180-3587	CAP 1000uF 50V
C808	0180-0230	C-F 1uF 50V
C809, 810	0180-4129	CAP 1uF 35V
C811, 812	0160-4834	CAP .047uF 10%
C813	0180-2980	C-F 1000uF 50V
C814, 815	0180-4129	CAP 1uF 35V
C8 16, 817	0180-4405	CAP 470 uF 50V
C818, 819	0180-0230	C-F 1uF 50V
C820, 821, 822	0180-4129	CAP 1uF 35V

Table 5-10. A6 Bias Assembly, Replaceable Parts (continued)

Ref. Desig.	Agilent Part No.	Description
C823	0180-4131	CAP 4.7uF 35V
C824, 825	0180-3298	C-F 2200uF 50V
C826	0160-4834	CAP .047uF 10%
C827	0180-3587	CAP 1000uF 50V
C828	0180-0230	C-F 1uF 50V
C829, 830, 831	0180-4129	CAP 1uF 35V
C841	0180-4397	C-F 100uF 63V
C842	0180-4131	CAP 4.7uF 35V
C843, 844, 845	0160-4835	CAP .1uF 10% 50V
C846	0180-4131	CAP 4.7uF 35V
C847	0180-0228	C-F 22uF 15V
D800, 801, 802,803,804,805	1901-0731	DIO-PWR RECT
D806, 807, 808,809,810,811	1901-0731	DIO-PWR RECT
D812, 813, 814,815,816,817	1901-0731	DIO-PWR RECT
D818, 819	1901-0731	DIO-PWR RECT
D820	1902-0018	DIO-ZNR 1N941
D830	1901-1098	DIO-IN4150
D832	1902-3393	DIO-ZNR 75V 55°
F800	2110-0712	FU-SUBMIN 4A
F803, 804, 805, 806	2110-0679	FUSE 1.5AM, 125V
J801	1252-1670	CONNECTOR
J809	1252-8837	CONNECTOR
J816	1252-0056	CONNECTOR
J821	1252-5230	CONNECTOR
J827	1251-7070	CONNECTOR
J830, 831	1252-0055	CONNECTOR
Q818, 819	5060-3245	HEAT SINK-TRANSISTOR (1854-0828) ASSY.
Q820, 821, 822	5060-3527	HEAT SINK-TRANSISTOR (1854-0828) ASSY.
R800	0683-3025	RES 3K 5% .25W
R801, 802	0683-0475	RES 4.7 5% .25W
R803	0698-0084	RES 2.15K 1%
R804	0698-3440	RES 196 1% .125W
R805, 806	8159-0005	RES-ZERO OHMS
R807, 808, 809	0698-0084	RES 2.15K 1%
R810	0698-3440	RES 196 1% .125W
R811	0699-0208	RES 1 5% .25W CF
R812, 813, 814, 815, 816	8159-0005	RES-ZERO OHMS
R817	0757-0442	RES 10K 1% .125W
R818	0698-6392	RES 22K .1%.125W
R819	0698-6631	RES 2.5K .1%
R820	0699-0070	RES 3.16M 1%
R821	0698-4493	RES 34K 1% .125W
R822	0757-0290	RES 6.19K 1%
R823	0757-0283	RES 2K 1% .125W
R824	0699-0070	RES 3.16M 1%
R825	0757-0444	RES 12.1K 1%
R827	0757-0274	RES 1.21K 1%
R828	0757-0444	RES 12.1K 1%
R831	0757-0290	RES 6.19K 1%
R833	0757-0280	RES 1K 1% .125W
R834	0757-0442	RES 10K 1% .125W
R835	0698-0085	RES 2.61K 1%
R836	0757-0442	RES 10K 1% .125W
R841	0698-6363	RES 40K .1%

Table 5-10. A6 Bias Assembly, Replaceable Parts (continued)

Ref. Desig.	Agilent Part No.	Description
R842	0698-6360	RES 10K .1%
R843	0757-0472	RES 200K 1%
R844	0698-6977	RES 30K .1% .125
R845, 847	0698-6360	RES 10K .1%
R848	0698-6977	RES 30K .1% .125
R849	0683-3325	RES 3.3K 5% .25W
R850	0698-6977	RES 30K .1% .125
R851	0698-4037	RES 46.4 1%
R852	0683-3325	RES 3.3K 5% .25W
R853, 854, 855	0683-1005	RES 10 5% .25W
R856	0698-3152	RES 3.48K 1%
R857	0698-4037	RES 46.4 1%
R858, 859, 860	0683-1005	RES 10 5% .25W
R861	0698-8234	RES 12.1K 1%
R862	0699-0070	RES 3.16M 1%
R863	0757-0469	RES 150K 1%
R864	0699-0070	RES 3.16M 1%
R865	0757-0464	RES 90.9K 1%
R867	0757-0290	RES 6.19K 1%
R868	0757-0199	RES 21.5K 1%
R869	0757-0281	RES 2.74K 1%
R870	8159-0005	RES-ZERO OHMS
R871	0698-3440	RES 196 1% .125W
R872	0698-0084	RES 2.15K 1%
R873	8159-0005	RES-ZERO OHMS
R874	0757-0274	RES 1.21K 1%
R875	0698-4037	RES 46.4 1%
R876, 877, 878	0683-1005	RES 10 5% .25W
R879, 880	8159-0005	RES-ZERO OHMS
T801	9100-5040	XFMR- GPIB
T802	9100-5041	XFMR-BIAS
U801	5060-2942	HEAT SINK-LM317T REGULATOR ASSY.
U802	5060-2948	HEAT SINK-UA7805UC REGULATOR ASSY.
U803	5060-2942	HEAT SINK-LM317T REGULATOR ASSY.
U804	5060-2943	HEAT SINK-LM337T REGULATOR ASSY.
U805	5060-2942	HEAT SINK-LM317T REGULATOR ASSY.
U806	1826-0544	IC-V RGLTR 2.5V MC1403U
U807	1826-0138	IC COMPARATOR LM339N
U808	1858-0047	XSTR ARY 16P-DIP
U809, 810, 811	1990-1074	OPTO-ISOLATOR 4N35
U812	1826-0161	IC LM324N
U813	1990-1074	OPTO-ISOLATOR 4N35
MECHANICAL PARTS		
	5080-2292	CABLE PRIMARY BIAS Ref: E800-E804 to DCRAIL J432

Table 5-11. A7 Snubber Assembly, Replaceable Parts

Ref. Desig.	Agilent Part No.	Description
ELECTRICAL PARTS		
C910, 911, 912, 913		
6680A, 6681A	0160-0162	CAP .022uF 10%
6682A	0160-6896	CAP .015uF 10%
6683A	0160-4845	CAP 6800pF 10%
6684A	0160-6162	CAP 4700pF 10%
R910, 911, 912, 913		
6680A, 6681A	0698-3601	RES 10 5% 2W MO
6682A	0698-3611	RES 27 5% 2W MO
6683A	0764-0013	RES 56 5% 2W MO
6684A	0698-3614	RES 43 5% 2W MO
R914, 915, 916, 917, 918		
6680A, 6681A	not used	
6682A	0698-3611	RES 27 5% 2W MO
6683A	0764-0013	RES 56 5% 2W MO
6684A	0698-3614	RES 43 5% 2W MO
R919, 920, 921		
6680A, 6681A	not used	
6682A	0698-3611	RES 27 5% 2W MO
6683A	0764-0013	RES 56 5% 2W MO
6684A	0698-3614	RES 43 5% 2W MO
MECHANICAL PARTS		
6680A, 6681A	5060-3327	WIRE KIT (2 required) Ref: D900,D901,D902,D903
6682A, 6683A, 6684A	5060-3365	WIRE KIT Ref: D900A,B,D901A,B

Table 5-12. A7 Fast Sense Assembly, Replaceable Parts

Ref. Desig.	Agilent Part No.	Description
ELECTRICAL PARTS		
	06680-60023	FAST SENSE PC ASSEMBLY Ref:6680A POWER SUPPLY
	06681-60023	FAST SENSE PC ASSEMBLY Ref:6681A POWER SUPPLY
	06682-60023	FAST SENSE PC ASSEMBLY Ref:6682A POWER SUPPLY
	06683-60023	FAST SENSE PC ASSEMBLY Ref:6683A POWER SUPPLY Ref:6681A POWER SUPPLY
	06684-60023	FAST SENSE PC ASSEMBLY Ref:6684A POWER SUPPLY
C1000	0160-5468	CAP 0.47uF 50V
MECHANICAL PARTS		
	5080-2287	CABLE Ref: EI001-EI003 to CONTROL J512

Table 5-13. A9 Down Programmer/Slow Sense, Replaceable Parts

Ref. Desig.	Agilent Part No.	Description
ELECTRICAL PARTS		
C950, 951	0160-4259	CAP .22uF 10%
C952, 953	0160-4048	CAP .022uF 20%
C956, 957	0160-4065	CAP .1uF 20%
C958, 980	0160-4835	CAP .1uF 10% 50V
D980, 981	1901-1098	DIO-IN4150
F980, 981		
6680A, 6681A	2110-0697	FU-SUBMIN 15A
6682A, 6683A, 6684A	2110-0916	FU-SUBMIN 7A
Q980	1853-0510	XSTR PNP
R940		
6680A, 6681A	0811-3705	RES .01 3W
6682A, 6683A	0811-3691	RES .025 3W
6684A	0699-1060	RES .05 3W
R941		
6680A, 6681A	0811-3705	RES .01 3W
6682A	0811-3691	RES .025 3W
6683A, 6684A	0699-1060	RES .05 3W
R945, 946		
6680A	0698-3609	RES 22 5% 2W MO
6681A	0698-3614	RES 43 5% 2W MO
6682A	0698-3633	RES 390 5% 2W MO
6683A	0698-3637	RES 820 5% 2W MO
6684A	0698-3338	RES 1.5K 5% 2W MO
R950, 951, 952, 953	0683-5605	RES 56 5% .25W
R954, 955, 958, 959	0699-0208	RES 1 5% .25W CF
R960	0683-2755	RES 2.7M 5% .25W
R961	not used	
R980	0757-0451	RES 24.3K 1%
R981	0698-4416	RES 169 1% .125W
R982	0757-0273	RES 3.01K 1%
R983, 984	0698-0082	RES 464 1% .125W
U900		
6680A 6681A	1826-0890	IC 358A
6682A, 6683A, 6684A	1826-1409	LT1013
Z900, 901	1902-0960	DIO ZNR 12V 5%
Q981, 982*		
6680A, 6681A	1855-0874	POWER MOSFET
6682A, 6683A, 6684	1855-1003	POWER MODFET
	0340-1507	INSULATOR (REF Q981,982)
	5080-2212*	CABLE Ref: J910 to CONTROL J510
* not supplied as part of downprogrammer assy		

Table 5-14. A10 Control Assembly, Replaceable Parts

Ref. Desig.	Agilent Part No.	Description
ELECTRICAL PARTS		
C500, 501, 502	0180-4129	CAP 1uF 35V
C503	0160-4835	CAP .1uF 10% 50V
C504	0180-4129	CAP 1uF 35V
C505	0180-4131	CAP 4.7uF 35V
C506	0160-4835	CAP .1uF 10% 50V
C507	0180-4136	CAP 10uF 20V
C508	0160-4831	CAP 4700pF 10%
C509, 510	0180-4129	CAP 1uF 35V
C511	0160-5422	CAP .047uF 20%
C512	0160-5644	CAP .033uF 10%
C513	0160-4789	CAP 15pF 5% 100V
C514, 515	0160-4805	CAP 47pF 5% 100V
C516	0160-5422	CAP .047uF 20%
C517	0180-4129	CAP 1uF 35V
C518, 519	0160-4835	CAP 1uF 10% 50V
C520	0160-4822	CAP 1000pF 5%
C521	0160-4832	CAP .01uF 10%
C530, 531, 532	0160-5422	CAP .047uF 20%
C533, 534, 534	0160-4801	CAP 100pF 5%
C536, 537, 538	0160-5422	CAP .047uF 20%
C539	0160-4846	CAP 1500pF 100V
C540, 541, 542, 543	0160-5469	C-F 1uF 10% 50V
C544	0160-4835	CAP .1uF 10% 50V
C545, 546	0160-4801	CAP 100pF 5%
C547	0180-2264	C-F 3.3uF 15V
C548		
6680A, 6681A	0160-4855	CAP 0.1uF 50V
C556, 560	0160-4835	CAP .1uF 10% 50V
C561	0160-4904	CAP 680pF 5%
C562	0160-4791	CAP 10pF 5% 100V
C563, 564	0160-4835	CAP .1uF 10% 50V
C565	0160-4791	CAP 10pF 5% 100V
C566	0160-4795	CAP 4.7pF
C567	0160-4904	CAP 680pF 5%
C568, 569	0160-4787	C-F 22pF 5% 100V
C570	0160-4795	CAP 4.7pF
C571	0180-4129	CAP 1uF 35V
C572	0180-4131	CAP 4.7uF 35V
C573	0160-4835	CAP .1uF 10% 50V
C574	0160-4805	CAP 47pF 5% 100V
C575, 576	0160-5098	CAP .22uF 10%
C577, 578	0160-4824	CAP 680pF 100v
C579, 580	0160-4835	CAP .1uF 10% 50V
C581	0160-4797	CAP 3.3pF
C583	0160-4807	CAP 33pF 5% 100V
C584	0160-4797	CAP 3.3pF
C585	0160-4834	CAP .047uF 10%
C586	0160-4835	CAP .1uF 10% 50V
C587		
6680A	0160-4814	CAP 150pF 5%
6681A	0160-4801	CAP 100pF 5%
6682A, 683A, 6684A	0160-4813	CAP 180pF 5%

Table 5-14. A10 Control Assembly, Replaceable Parts (continued)

Ref. Desig.	Agilent Part No.	Description
C588	0160-4799	CAP 2.2pF 5%
C589, 590		
6680A, 6681A	not used	
6682A, 6683A, 6684A	0160-4824	CAP 680pF 5%
C591		
6680A	0160-4814	CAP 150pF 5%
6681A	0160-4801	CAP 100pF 5%
6682A, 683A, 6684A	0160-4813	CAP 180pF 5%
C592	0160-4835	CAP .1uF 10% 50V
C594	0160-4799	CAP 2.2pF
C595	0160-5098	CAP .22uF 10%
C596		
6680A, 6681A	0160-4811	CAP 270pF 5%
6682A, 683A, 6684A	0160-4831	CAP 4700pF 5%
C597	0160-4795	CAP 4.7pF
C598		
6680A, 6681A	0160-4831	CAP 4700pF 10%
6682A, 6683A	0160-4830	CAP 2200pF 10%
6684A	0160-4831	CAP 4700pF 10%
C599, 600, 601	0160-4835	CAP .1uF 10% 50V
C621	0160-4795	CAP 4.7pF
C622	0160-5534	CAP 0.1uF 10% 63V
C624		
6680A	0160-5267	CAP 4700pF 5%
6681A	0160-5410	CAP 3300pF 5%
6682A	0160-4904	CAP 6800pF 5%
6683A, 6684A	0160-5267	CAP 4700pF 5%
C625		
6680A	0160-4819	CAP 2200pF 100V
6681A	0160-4846	CAP 1500pF 100V
6682A	0160-4821	CAP 1200pF 100V
6683A	0160-4824	CAP 680pF 10V
6684A	0160-4808	CAP 470pF 10V
C626, 627	0180-4136	CAP 10uF 20V
C628	0160-4835	CAP .1uF 10% 50V
C629	0160-4799	CAP 2.2pF
C630		
6680A	0160-4904	CAP 6800pF 5%
6681A	0160-5410	CAP 3300pF 5%
6682A	0160-4812	CAP 220pF 5%
6683A, 6684A	0160-4810	CAP 330pF 5%
C631		
6680A	0160-5534	CAP 0.1uF 10%
6681A	0160-5892	CAP 0.22uF 10%
6682A, 6683A, 6684A	0160-5469	CAP 1uF 10%
C632, 633	0160-4791	CAP 10pF 5% 100V
C635, 636		
6680A	0160-5468	CAP 0.47uF 10% 50V
6681A	0160-5469	CAP 1uF 10% 50V
6682A	0160-5892	CAP 0.22uF 10% 50V
6683A, 6684A	0160-5468	CAP 0.47uF 10% 50V
C637		
6680A, 6681A	0160-4808	CAP 470pF 5%
6682A, 6683A, 6684A	0160-4812	CAP 220pF 5%

Table 5-14. A10 Control Assembly, Replaceable Parts (continued)

Ref. Desig.	Agilent Part No.	Description
C639	0160-4795	CAP 4.7pF
C640	0160-4835	CAP .1uF 10% 50V
C641	0160-5410	CAP 3300pF 5%
C645	0160-4805	CAP 47pF 5% 100V
C648	0160-4831	CAP 4700pF 10%
C650	0160-4833	CAP .022uF 10%
C651	0160-7277	CAP 2.2uF 50V
C652	0160-4832	CAP .01uF 10%
C653	0160-5892	CAP 0.22uF 10%
C654, 655	0160-4183	CAP 1000pF 20%
C656		
6680A, 6681A	0160-5892	CAP 0.22uF 10%
6682A, 6683A, 6684A	0160-5469	CAP 1uF 10% 50V
C657		
6680A, 6681A	not used	
6682A, 6683A, 6684A	0160-5534	CAP 0.1uF 10%
C658, 659	0160-4183	CAP 1000pF 20%
C710, 711	0160-4835	CAP .1uF 10% 50V
C715		
6680A, 6681A	not used	
6682A, 6683A, 6684A	0160-4824	CAP 680pF 5%
C735	0683-1005	RES 10 5% .25W
D500, 501, 502	1901-0731	DIO-PWR RECT
D503, 504, 505,506,507,508	1901-1098	DIO-1N4150
D530, 531, 532,533,534,535	1901-1098	DIO-1N4150
D536, 538	1901-1098	DIO-1N4150
D539	1901-0880	DIO GEN PRP
D540	1901-1098	DIO-1N4150
D560, 561	1901-0880	DIO GEN PRP
D637	1901-1098	DIO-1N4150
D651, 652	1901-1098	DIO-1N4150
D653, 654	1901-0880	DIO GEN PRP
D655, 656	1901-1098	DIO-1N4150
D657	1901-0880	DIO GEN PRP
D658, 659	1901-1098	DIO-1N4150
D670	1901-0880	DIO GEN PRP
D671	1901-1098	DIO-1N4150
D672, 673, 674, 675, 676	1901-0880	DIO GEN PRP
D677, 678, 679, 680	1901-1098	DIO-1N4150
J507	1251-7330	PHONE RECEPTABLE
J509	1252-1992	CONNECTOR 16 pin
J510	1252-1152	CONNECTOR 10 pin
J511	1252-0055	CONNECTOR 2 pin
J512	1252-0056	CONNECTOR 4 pin
J513	1252-3693	CONNECTOR 7 pin
L500	9140-0158	COIL IUH 10%
Q610	1853-0510	XSTR PNP
Q621, 622, 623	1855-0413	J-FET P-CHAN
R500	0757-0346	RES 10 1% .125W
R501, 502	0698-3155	RES 4.64K 1%
R503	0757-0273	RES 3.01K 1%
R504	0757-0442	RES 10K 1% .125W
R505	0757-0434	RES 3.65K 1%

Table 5-14. A10 Control Assembly, Replaceable Parts (continued)

Ref. Desig.	Agilent Part No.	Description
R506	0757-0289	RES 13.3K 1%
R507	0698-3155	RES 4.64K 1%
R508	0698-6323	RES 100.1%
R509	0757-0442	RES 10K 1% .125W
R510	0757-0289	RES 13.3K 1%
R511	0698-3155	RES 4.64K 1%
R512	0757-0472	RES 200K 1%
R513	0757-0199	RES 21.5K 1%
R514	0698-3279	RES 4.99K 1%
R515	0757-0472	RES 200K 1%
R516	0698-3456	RES 287K 1%
R517	0698-3279	RES 4.99K 1%
R518	0757-0442	RES 10K 1% .125W
R519	0698-3279	RES 4.99K 1%
R520	0757-0442	RES 10K 1% .125W
R521	0757-0465	RES 100K 1%
R522	0757-0289	RES 13.3K 1%
R523, 524	0757-0280	RES 1K 1% .125W
R525, 526	0757-0442	RES 10K 1% .125W
R527	0699-1212	RES 19K .1%
R528	0698-6392	RES 22K .1%.125W
R529	0757-0283	RES 2K 1% .125W
R530	1810-0305	NETWORK-RES SIP
R531	0698-4446	RES 267 1% .125W
R532	0757-0273	RES 3.01K 1%
R533	0698-3155	RES 4.64K 1%
R534	0699-0070	RES 3.16M 1%
R535	0757-0468	RES 130K 1%
R536		
6680A	0757-0290	RES 6.19K 1% .125W
6681A	0757-0442	RES 10K 1% .125W
6682A	0698-4486	RES 24.9K 1%
6683A	0698-6076	RES 39K 1%
6684A	0757-0457	RES 47.5K 1%
R537		
6680A	8159-0005	RES 0.0
6681A	0698-8827	RES IM 1%
6682A, 6683A	0699-0070	RES 3.16M 1%
6684A	not used	
R538		
6680A, 6681A	0698-8827	RES IM 1%
6682A	0699-1972	RES 1.74M 1%
6683A	0699-0070	RES 3.16K
R539	0757-0438	RES 5.11K 1%
R540	0757-0428	RES 1.62K 1%
R550, 551, 552	0757-0401	RES 100 1% .125W
R553, 554	0757-0465	RES 100K 1%
R555	0757-0462	RES 75K 1% .125W
R556	0698-3450	RES 42.2K 1%
R557	0757-0280	RES 1K 1% .125W
R558, 559	0698-3456	RES 287K 1%
R560, 561, 562, 563	0698-4486	RES 24.9K 1%
R564, 565, 566, 567	0699-0642	RES 10K .1% .1W
R568, 569	0698-3279	RES 4.99K 1%

Table 5-14. A10 Control Assembly, Replaceable Parts (continued)

Ref. Desig.	Agilent Part No.	Description
R570, 580	0757-0424	RES 1.1K 1%
R581	0757-0407	RES 200 1% .125W
R582, 583	0698-4486	RES 24.9K 1%
R584	0757-0472	RES 200K 1%
R585	0757-0434	RES 3.65K 1%
R586	0757-0472	RES 200K 1%
R587	0757-0407	RES 200 1% .125W
R588, 589	0757-0442	RES 10K 1% .125W
R590	0699-0070	RES 3.16M 1%
R591, 592	0757-0472	RES 200K 1%
R593	0699-0070	RES 3.16M 1%
R594	0757-0280	RES 1K 1% .125W
R595	0757-0273	RES 3.01K 1%
R596	0757-0442	RES 10K 1% .125W
R597	0757-0199	RES 21.5K 1%
R598	0757-0273	RES 3.01K 1%
R599, 600	0757-0427	RES 1.5K 1%
R601, 602	0757-0401	RES 100 1% .125W
R603	0698-4446	RES 267 1% .125W
R604	0698-3279	RES 4.99K 1%
R605, 606	0698-3430	RES 21.5 1%
R607	0698-4479	RES 14K 1% .125W
R608, 609	0757-0429	RES 1.82K 1%
R610		
6680A	0757-0462	RES 75K 1%
6681A, 6682A	0757-0465	RES 100K 1%
6683A, 6684A	0757-0465	RES 100K 1%
R611	0698-3450	RES 42.2K 1%
R612	0757-0442	RES 10K 1% .125W
R613	0698-3155	RES 4.64K 1%
R614	0698-3279	RES 4.99K 1%
R615	0698-3162	RES 46.4K 1%
R616	0757-0410	RES 301 1% .125W
R617	0698-0082	RES 464 1% .125W
R618	0757-0410	RES 301 1% .125W
R619	0757-0453	RES 30.1K 1%
R620		
6680A, 6681A	not used	
6682A	0698-3136	RES 17.8K 1%
6683A, 6684A	0757-0446	RES 15K 1%
R621		
6680A, 6681A	0757-0453	RES 30.1K 1%
6682A	0757-0462	RES 75K 1%
6683A	0757-0467	RES 121K 1%
6684A	0757-0469	RES 150K 1%
R622		
6680A, 6681A	not used	
6682A	0698-3136	RES 17.8K 1%
6683A, 6684A	0757-0446	RES 15K 1%
R623		
6680A, 6681A	0757-0453	RES 30.1K 1%
6682A	0757-0462	RES 75K 1%
6683A	0757-0467	RES 121K 1%
6684A	0757-0469	RES 150K 1%

Table 5-14. A10 Control Assembly, Replaceable Parts (continued)

Ref. Desig.	Agilent Part No.	Description
R624	0757-0453	RES 30.1K 1%
R625		
6680A, 6681A	0698-3455	RES 261K 1%
6682A	0757-0461	RES 68.1K 1%
6683A, 6684A	0699-1972	RES 1.74M 1%
R626		
6680A, 6681A	0698-3455	RES 261K 1%
6682A	0699-0088	RES 1.21M 1%
6683A, 6684A	0757-0480	RES 432K 1%
R627, 628	0698-3455	RES 261K 1%
R629	0698-4479	RES 14K 1% .125W
R632	0757-0273	RES 3.01K 1%
R633	0757-0465	RES 100K 1%
R634	0757-0442	RES 10K 1% .125W
R635	0698-3450	RES 42.2K 1%
R636	0757-0280	RES 1K 1% .125W
R637		
6680A, 6681A, 6682A	0757-0465	RES 100K 1%
6683A	0757-0466	RES 110K 1%
6684A	0757-0464	RES 90.0K 1%
R638	0698-3279	RES 4.99K 1%
R639		
6680A, 6681A	0757-0463	RES 82.5K 1%
6682A	0757-0464	RES 90.9K 1%
6683A	0757-0466	RES 110K 1%
6684A	0757-0464	RES 90.9K 1%
R640	0698-3279	RES 4.99K 1%
R641		
6680A, 6681A	0757-0452	RES 27.4K 1%
6682A, 6683A, 6684A	0698-3156	RES 14.7K 1%
R642	0757-0410	RES 301 1%
R643	0757-0429	RES 1.82K 1%
R644	0757-0434	RES 3.65K 1%
R645		
6680A	0698-8827	RES 1M 1%
6681A, 6682A	0699-0070	RES 3.16M 1%
6683A, 6684A	0699-0070	RES 3.16M 1%
R646		
6680A, 6681A	0699-0088	RES 1.2M 1%
6682A, 6683A, 6684A	0698-3215	RES 499K 1%
R658, 659	0757-0278	RES 1.78K 1%
R660	0698-8827	RES 1M 1% .125W
R661		
6680A	0757-0433	RES 3.32K 1%
6681A	0757-0430	RES 2.21K 1%
6682A	0757-0427	RES 1.5K 1%
6683A, 6684A	0757-0280	RES 1K 1%
R662	0757-0273	RES 3.01K 1%
R663	0698-3456	RES 287K 1%
R664	0698-3155	RES 4.64K 1%
R665	0757-0273	RES 3.01K 1%

Table 5-14. A10 Control Assembly, Replaceable Parts (continued)

Ref. Desig.	Agilent Part No.	Description
R666		
6680A	0698-8913	RES 1.5M 1%
6681A, 6682A	0683-2255	RES 2.2M 1%
6683A	0683-4755	RES 4.7M 1%
6684A	0683-5655	RES 5.6M 1%
R667		
6680A	0757-0465	RES 100K 1
6681A	0757-0462	RES 75K 1%
6682A, 6683A	0698-3455	RES 261K 1%
6684A	0757-0473	RES 221K 1%
R668	0698-3279	RES 4.99K 1
R669		
6680A	0757-0462	RES 75K 1%
6681A	0698-4503	RES 66.5K 1%
6682A	0757-0273	RES 3.01K 1%
6683A	0757-0480	RES 432K 1%
6684A	0698-3456	RES 287K 1%
R670		
6680A	0699-1742	RES 70K 1%
6681A, 6682A	0699-1211	RES 95K 1%
6683A, 6684A	0699-0460	RES 85K 1%
R671	0699-0070	RES 3.16M 1%
R672		
6680A	0698-8093	RES 40K 1%
6681A, 6682A	0699-0118	RES 20K 1%
6683A, 6684A	0699-0461	RES 30K .1%
R673	0699-2247	RES 121K .05%
R674	0699-0461	RES 30K .1% .1W
R675	0698-3279	RES 4.99K 1%
R677	0699-0461	RES 30K .1% .1W
R678, 679		
6680A	0699-3414	RES 45K
6681A, 6682A	0699-2246	RES 25K 0.05%
6683A, 6684A	0699-2246	RES 25K 0.05%
R680		
6680A, 6681A	0699-3103	RES 19K 0.05%
6682A	0699-2248	RES 47.5K 0.05%
6683A	0699-2879	RES 80K 0.05%
6684A	0699-3416	RES 100K 0.05%
R681		
6680A, 6681A	0699-3103	RES 19K 0.05%
6682A	0699-2248	RES 47.5K 0.05%
6683A	0699-2879	RES 80K 0.05%
6684A	0699-3416	RES 100K 0.05%
R682		
6680A	0698-6322	RES 4K 0.1%
6681A	0698-7163	RES 2.0081K 0.1%
6682A	0698-8061	RES 8.25K 0.1%
6683A, 6684A	0698-6322	RES 4K 0.1%
R683		
6680A	0698-6322	RES 4K 0.1%
6681A	0698-7163	RES 2.0081K 0.1%
6682A	0698-8061	RES 8.25K 0.1%
6683A, 6684A	0698-6322	RES 4K 0.1%

Table 5-14. A10 Control Assembly, Replaceable Parts (continued)

Ref. Desig.	Agilent Part No.	Description
R684		
6680A	0757-0280	RES 1K 1%
6681A	0757-0289	RES 1K 1%
6682A	0757-0430	RES 2.21K 1%
6683A	0698-3496	RES 3.57K 1%
6684A	0757-0436	RES 4.32K 1%
R685		
6680A	0757-0280	RES 1K 1%
6681A	0757-0289	RES 1K 1%
6682A	0757-0430	RES 2.21K 1%
6683A	0698-3496	RES 3.57K 1%
6684A	0757-0436	RES 4.32K 1%
R686		
6680A	8159-0005	RES 0.0
6682A	0698-8911	RES 1.3K .1%
6683A	0699-0486	RES 2.0K .1%
6684A	8159-0005	RES 0.0
R687	0698-8093	RES 40K .1% .1W
R689	0698-5365	RES 3.48K .1%
R690		
6680A, 6681A	0757-0395	RES 56.2
6682A, 6683A	0757-0403	RES 121
6684A	0698-6362	RES 1.0K .1%
R691		
6680A, 6681A	0699-1011	RES 3.32K .1%
6682A	0698-8911	RES 1.3K .1%
6683A	0698-7163	RES 2.0081K .1%
6684A	0698-8911	RES 1.3K .1%
R692	0698-6620	RES 150K .1%
R693, 694	0698-3430	RES 21.5 1%
R695	0698-8093	RES 40K .1% .1W
R696, 697	0698-6414	RES 1K .1% .1W F
R698, 699	0698-6323	RES 100 1%
R701, 702	0757-0442	RES 10K 1% .125W
R703		
6680A	0757-0446	RES 15K 1%
6681A, 6682A	0757-0443	RES 11K 1%
6683A, 6684A	0757-0443	RES 11K 1%
R704	0683-1065	RES 10M 5% .25W
R705		
6680A	0699-0070	RES 3.16M
6681A, 6682A	0683-2255	RES 2.2M
6683A, 6684A	0683-2255	RES 2.2M
R706	8159-0005	RES-ZERO OHMS
R707		
6680A	0699-0088	RES 1.21M
6681A, 6682A	0698-8826	RES 825K
6683A, 6684A	0698-8826	RES 825K
R708		
6680A	0698-3459	RES 383K
6681A, 6682A	0698-3455	RES 261K
6683A, 6684A	0698-3455	RES 261K

Table 5-14. A10 Control Assembly, Replaceable Parts (continued)

Ref. Desig.	Agilent Part No.	Description
R709		
6680A	0757-0468	RES 130K
6681A, 6682A	0757-0464	RES 90.9K
6683A, 6684A	0757-0464	RES 90.9K
R710		
6680A	0698-5091	RES 45K
6681A, 6682A	0698-3160	RES 31.6K
6683A, 6684A	0698-3160	RES 31.6K
R711	0698-5091	RES 45K
R712	0698-0082	RES 464 1% .125W
R713	0757-0442	RES 10K 1% .125W
R714	0757-0349	RES 22.6K 1%
R715	0757-0447	RES 16.2K 1%
R716	0698-3449	RES 28.7K 1%
R717		
6680A, 6681A	not used	
6682A, 6683A, 6684A	0757-0442	RES 10K
R718	0698-3162	RES 46.4K 1%
R719	0757-0458	RES 51.1K 1%
R720	0698-8093	RES 40K .1% .1W
R721	0698-6630	RES 20K .1%
R724	0698-3279	RES 4.99K 1%
R725		
6680A, 6681A	not used	
6682A, 6683A, 6684A	0757-0199	RES 21.5K
R726	0698-6359	RES 80K .1%
R727, 728	0698-6630	RES 20K .1%
R729	0698-6359	RES 80K .1%
R730, 731	0698-6630	RES 20K .1%
R732	0698-6619	RES 15K .1%
R733	0699-0489	RES 16.15K .1%
R734	0683-2255	RES 2.2M 5% .25W
R738	0698-8959	RES 619K 1%
R741		
6680A	0757-0429	RES 1.82K
6681A	0698-3496	RES 3.57K
6682A	0757-0436	RES 4.32K
6683A	0698-3496	RES 3.57K
6684A	0698-3151	RES 2.87K
R742	0698-4509	RES 80.6K 1%
R743	0698-8093	RES 40K .1% .1W
R744	0683-0475	RES 4.7 5% .25W
R745	0698-6630	RES 20K .1%
RT500	0837-0397	Thermistor
S500	3101-1973	SW-SL 7-1A
U500	1826-2341	IC-REG TL7702BCP
U501, 502	1826-1370	IC 365
U503	1826-0346	IC OP AMP
U504	1826-1369	IC-VOLTAGE REG

Table 5-14. A10 Control Assembly, Replaceable Parts (continued)

Ref. Desig.	Agilent Part No.	Description
U506	5080-2305	PRGMD-IC, SEC
U507	1820-3079	IC MC74HC138N
U510, 511, 512	1826-2187	IC-CONVERTER,DIA
U513, 514, 515	1826-1896	IC-LINEAR
U516, 517	1826-1370	IC 365
U518	1820-3081	IC MC74HC74N
U520	1826-1231	DIA 8-DGT
U521, 522	1826-1409	IC 1013
U600	1820-3199	IC MC74HC4040N
U601	1820-2922	IC MC74HC00N
U602	1820-3081	IC MC74HC74N
U603	1826-2343	IC-VRGLTR,SWG
U604	1820-2922	IC MC74HC00N
U605	1826-0065	IC 311
U606	1858-0083	XSTR ARY 14P-DIP
U607, 608	1826-0962	IC 412
U609	1826-0890	IC 358A
U610	1826-1343	IC-VOLTAGE REG
U620, 621	1826-1409	IC 1013
U622	1826-1895	PRECISION OP-AMP
U623	1826-1896	IC-LINEAR
U624	1826-0161	IC 324
Z500	1902-3114	DIO-ZNR 6.19V 2%
Z501	1902-0777	DIO-ZNR 1N825
Z641	1902-1377	DIO-ZNR 6.19V

Diagrams

Introduction

This chapter contains drawings and diagrams for troubleshooting and maintaining Agilent Series 668xA Power Supplies. Unless otherwise specified, a drawing or diagram applies to all models of the series. Wiring connections to external equipment are shown in the Power Supply Operating Manual.

Chapter Organization

Table 6-1 summarizes the contents of this chapter.

Table 6-1. Summary of Chapter Contents

Function	Description	See
Interconnections	Drawing identifying each circuit board, the cables between boards, and schematic diagram for each board.	Figure 6-2
Schematics	Show test points, signal mnemonics, component-location grid coordinates, and specific notes. General notes applicable to all schematics are given in Table 6-4. A1 Front Panel Board. LED Board. A2 GPIB Board. A3 FET Board. A4 AC Input Power Board. A5 DC Rail Board. A6 Bias Board. A7 Snubber Board. A8 Fast Sense Board. A9 Down Programming/Slow Sense Board. A10 Control Board.	
Signal names	Table of signal name mnemonics	Table 6-2
Parts location	A drawing that shows the location of components on a circuit board is located next to the above circuit board schematic diagram. A drawing showing location of each circuit board in the chassis is in Chapter 3.	Figure 3-18
Test points	Description of each test point. Location of each test point is shown on the appropriate schematic and its associated parts location drawing.	Table 6-3

Table 6-2. Signal Name Mnemonics

Mnemonic	Description	Mnemonic	Description
A(0)--A(15)	Address lines	MSRQ	Microprocessor service request
AD (0)--AD(7)	Address bus	NDAC	Not data accepted (GPIB)
AMB_SENSE	Ambient temperature sense	NEG_IMON	Negative current monitor
ANA(0)--ANA(7)	Analog Signal readback bus	NRFD	Not ready or data (GPIB)
ATN	Attention (GPIB)	OV	Overvoltage
BIAS_OK	±15V bias supplies have stabilized	OV_CLR	Overvoltage clear
BOVPROG	BuFfered OV programming	OVCMP	Overvoltage comparator
BSTX	BuFfered secondary transmit	OVP_BIAS	Overvoltage protection bias
cc	Constant current status	OVPROG	Overvoltage programming
CCPROG	Constant current programming	OVSCR	Overvoltage SCR (crowbar)
cv	Constant voltage status	PCLR	Primary power clear
CVPROG	Constant voltage programming	PREF	Primary reference voltage (2.53V)
D(0)_D(7)	Data lines	PREF_2	Primary reference voltage (1.0V)
D101--DI08	Data lines (GPIB)	PREN	Primary remote enable
DAV	Data valid (GPIB)	PRX	Primary receive serial data
DFI	Discrete fault indicator	PTX	Primary transmit serial data
DFI-EN	Discrete fault indicator enable	PWM_EN	Pulse width modulator enable
DPS	Downprogramming shunt	RAM	Random access memory
DN_PGM	Down programming	RDY	Ready
DRIVE_A/B	FET drive signals	REN	Remote enable
EOI	End or identify (GPIB)	RI	Remote inhibit
FAC_CAL	Factory calibration	ROM	Read only memory
FAN_PWM	Fan pulse width modulation	SPCLR	Secondary power clear
FPRX	Front panel receive serial data	RX	Receive serial data
FPTX	Front panel transmit serial data	RxD	Receive Serial Data
FS	Fast sense	SA	Signature analysis
HSRQ	GPIB service request	SRQ	Service request (GPIB)
IFC	Interface clear (GPIB)	SRX	Secondary receive serial data
IMON	Current monitor	STX	Secondary transmit serial data
INH_CAL	Inhibit calibration	TxD	Transmit Serial Data
IP	External current programming	UART	Universal asynchronous receive/transmit
IPROG	Current programming	VMON	Voltage monitor
ISEN	Current sense	vos	Voltage offset
ISRQ	Interface service request	VPROG	Voltage programming
KO(0)-KO(5)	Keypad output data bus	WR	Write
KI(0)--KI(5)	Keypad input data bus		

Table 6-3. Test Points

TEST POINT No. & Loc.	Signal Tested	Measurement and Conditions
A2 GPIB BOARD		
<p>1 J106-4</p> <p>2 U101-1</p> <p>3 U101-6</p> <p>4 U101-8</p> <p>5 U110-3</p> <p>6 U111-6</p> <p>7 U119-4</p> <p>8 U119-18</p>	<p>Primary/chassis ground</p> <p>+ 5V primary bias</p> <p>PCLR</p> <p>PCLR*</p> <p>STX</p> <p>SRX</p> <p>FPRX</p> <p>FPTX</p>	<p>Connect meter or scope common here. Then make measurements at test points 2 through 8.</p> <p>+ 5V ± 0.2V</p> <p>Goes high for approximately 40 ms at power on, then goes low.</p> <p>Held low for approximately 40 ms at power on, then goes high.</p> <p>Primary transmit to secondary serial data line. Toggles between 0 and +5V.</p> <p>Primary receive from secondary serial data line. Toggles between 0 and +5V.</p> <p>Primary receive from front panel serial data line. Toggles between 0 and +5V.</p> <p>Primary transmit to front panel serial data line. Toggles between 0 and +5V.</p>
AC Input Board		
<p>Connect meter between TP 9 and 10, or 9 and 11, or 10 and 11, and measure approximately 220VAC or 440VAC. Measurements at test points 9 through 12.</p>		
<p>9 J418-1/J417-7</p> <p>10 J418-2/J417-8</p> <p>11 J418-3/J417-9</p> <p>12 K402 coil</p>	<p>AC Mains Voltage</p> <p>AC Mains Voltage</p> <p>AC Mains Voltage</p> <p>24VDC Coil Voltage</p>	<p>Turns on PS, and after power-on initialization test, reads approximately 24VDC.</p>
DC Rail Board		
<p>13 J430-1 (+) to J430-2 (-)</p> <p>14 J431-1 (+) to J431-2 (-)</p>	<p>Rail #1 Voltage</p> <p>Rail #2 Voltage</p>	<p>Measure approximately 290VDC</p> <p>Measure approximately 290VDC</p>
Bias Board		
<p>15 J801-4 to J801-5</p> <p>16 J801-1 (+) to J801-2 (-)</p> <p>17 J827-1 (+) to J827-2 (-)</p> <p>18 J827-1 (+) to J827-3 (-)</p> <p>19 R331</p> <p>16 R330</p> <p>17 +C354</p> <p>18 U310-16</p> <p>18 U308-6</p> <p>20 U308-7</p>	<p>GPIB 5V Bias</p> <p>Fan voltage</p> <p>Inrush relay coil</p> <p>Rail relay coil</p> <p>24V Primary</p> <p>-15Vs secondary bias</p> <p>-25V</p> <p>RELAY ON*</p> <p>RESET</p> <p>BIAS OK</p>	<p>+15 ± 0.9V measure approx. 11VAC</p> <p>Measure 24VDC</p> <p>Measure 24VDC</p> <p>Measure 24VDC after power-on initialization test.</p> <p>Measure approximately 34VAC</p> <p>-15 ± 0.9V</p> <p>-22.5V to -27.5V</p> <p>0V</p> <p>0V</p> <p>+5V</p>

Table 6-3. Test Points (continued)

TEST POINT No. & Loc.	Signal Tested	Measurement and Conditions
Bias Board (continued)		
21 U308-1	PREF	+2.5V
22 U308-5	RESET*	Held low for approximately 50 ms at power-on, then goes high.
23 U311-7	FAN DETECT	+3V
24 D317	-25V	+3V
25 U311-2	FAN_PWN	+0.6V
A3 FET Board		
Test points 26 through 35 are on the A3 FET Board. Troubleshooting procedures at these points are given under Dynamic Troubleshooting section of the FET Troubleshooting Chart (Table 3-4).		
A10 Control Board		
36 +C500	Secondary common (Sheet 1)	
37 U504-6	CC/CC DACs reference (Sheet 1)	
38 U503-7	Readback DAC reference (Sheet 1)	
39 U513-6	CVPROG (Sheets 2,4)	
40 U514-6	CVPROG (Sheets 2,4)	
	NOTE:	
	Measurements at test points through where taken under the following conditions:	
	1. Programming	a. Voltage = ½ scale
		b. Current = ½ scale
		c. OV = full scale
	2. First measurement in CV mode with no load.	
	3. Second measurement in CC mode with output shorted.	
41 U621-1	VMON (Sheet 4)	
42 U621-7	CV CONTROL (Sheet 4)	
43 U502-2	CV* (Sheet 4)	CV mode =0V CC mode = 5V
44 U624-1	CC CLAMP AMP output (Sheet 4)	CV mode =+2.2V CC mode = +2.2V
45 U622-6	1ST I AMP output (Sheet 4)	CV mode =0V CC mode = -0.4V
46 U620-7	2ND I AMP output (Sheet 4)	CV mode =0V CC mode = +4.5V
47 U620-1	CC CONTROL (Sheet 4)	CV mode =+10V CC mode = +0.4V
48 U502-3	CC* (Sheet 4)	CV mode =+5V CC mode = 0V
49 Y608-7	FAST SENSE AMP (Sheet 3)	CV mode = -4V CC mode = 0V
50 U607-7	RAMP GEN (Sheet 3)	See Figure 6-1
51 U607-1	RAMP GEN (Sheet 3)	See Figure 6-1
52 U602-9	DIVIDER output (Sheet 3)	See Figure 6-1
53 U605-3	SUMMING POINT (Sheet 3)	See Figure 6-1
54 U602-6	DEADTIME LATCH (Sheet 3)	See Figure 6-1
55 U605-7	SUMMING COMPARATOR (Sheet 3)	See Figure 6-1

Table 6-3. Test Points (continued)

TEST POINT No. & Loc.	Signal Tested	Measurement and Conditions
A10 Control Board (continued)		
56 U600-10	DIVIDER CLOCK (Sheet 3)	See Figure 6-1
57 U601-6	DIVIDER RESET (Sheet 3)	See Figure 6-1
58 U601-3	ON LATCH CLOCK (Sheet 3)	See Figure 6-1
59 U604-3	ON LATCH (Sheet 3)	See Figure 6-1
60 U603-3	PWM_EN (Sheet 3)	Held high for approximately 12 seconds at power-on, then goes low.
61 U603-13	VOS (Sheet 3)	+5 ± 0.2V
62 J511-1,2	NOTE: Temporarily move both scope leads to J511 for TP 62 DRV A, DRV B (Sheet 3)	See Figure 6-1
63 U502-14		+5V
64 U501-7	OVREF (Sheets 1,3)	+5.4V
65 Q602,C	DP CONTROL (Sheet 3)	CV Mode CC Mode Not Applicable -0.14V
66 U608-7	DP CONTROL (Sheet 3)	CV Mode CC Mode +13V 0V
67 U630-11	PREF_2 (Sheets 1,3)	+1V
68 U630-12	DN PGM (Sheets 1,3)	0V
69 D660-AN	DP_TST (Sheet 3)	0V
70 U502-12	OV COMPARATOR (Sheet 3)	CV Mode CC Mode +1.5V +3.25V

General Schematic Notes

The following table lists summary information about notes appearing in schematic diagrams.

Table 6-4. General Schematic Notes

<ol style="list-style-type: none"> All resistors are in ohms ±1%, 1/8W, unless otherwise specified. All capacitors are in microfarads unless otherwise specified. Signal lines that are terminated by flags continue on other sheets, and may also go to other locations on the same sheet. Example: CVPROG (SH.2 8C); "SH.2 8C" indicates the sheet number and the coordinates on that sheet where the CVPROG signal line goes. Unterminated signal lines go to a least one other location on the same sheet. Unless otherwise noted, bias connections to integrated-circuit packages are as follows: 			
	Common	+ 5V	
14-pin packages	pin 7	pin 14	
16-pin packages	pin 8	pin 16	
20-pin packages	pin 10	pin 20	

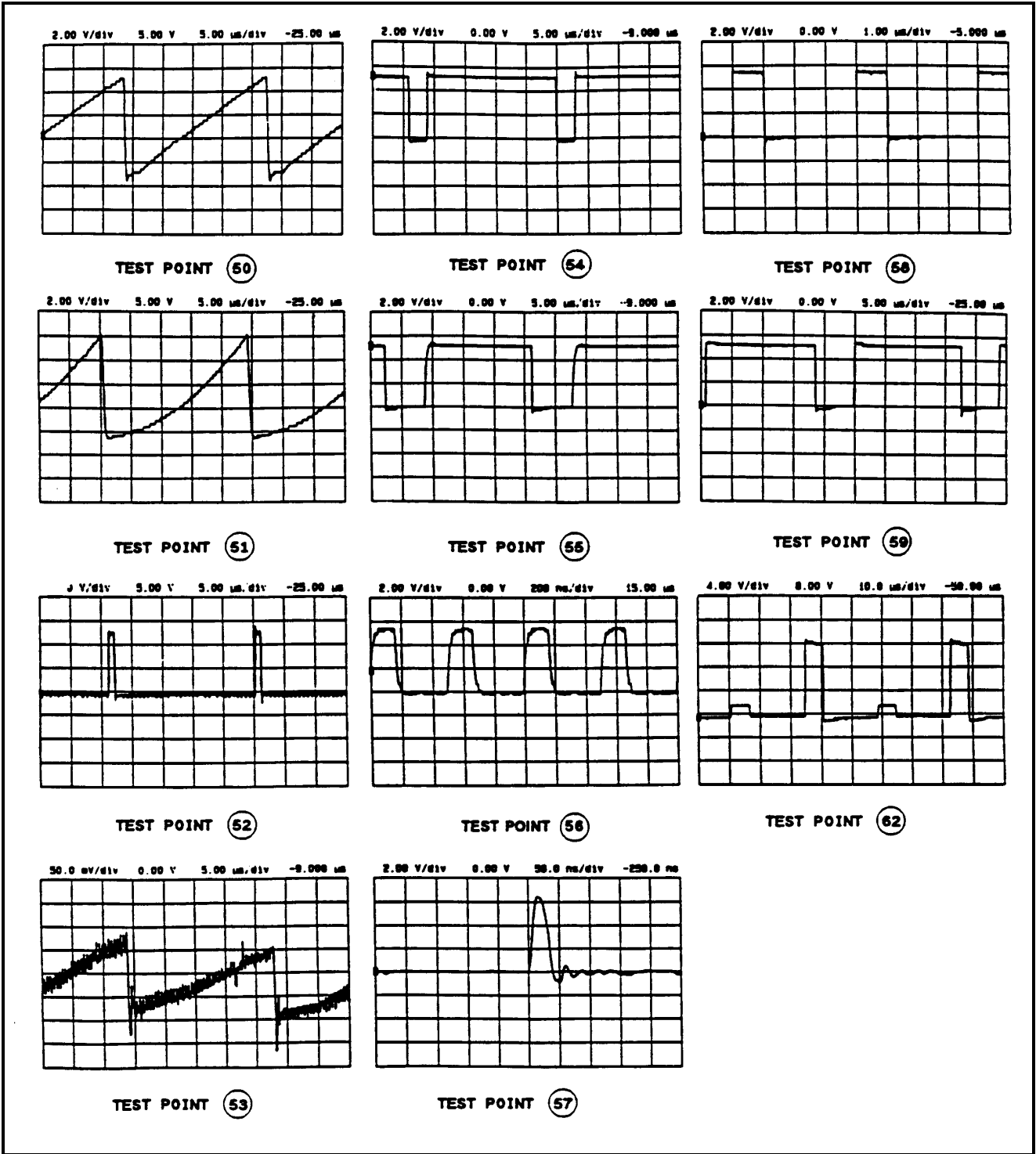

Figure 6-1. Test Point Waveforms for Table 6-3

Figure 6-2. Circuit Board Cabling Diagram Models

Figure 6-3. A1 Front Panel Board, Component and Test Point Location

Figure 6-4. A1 Front Panel Board, Schematic Diagram

Figure 6-5. LED Board, Component and Test Point Location

Figure 6-6. LED Board, Schematic Diagram

Figure 6-7. A2 GPIB Board, Component Location

Figure 6-8. A2 GPIB Board, Schematic Diagram

Figure 6-9. A3 FET Board, Component and Test Point Location

Figure 6-10. A3 FET Board, Schematic Diagram (sheet 1 of 2)

Figure 6-10. A3 FET Board, Schematic Diagram (sheet 2 of 2)

Figure 6-11. A4 AC Input Board, Component and Test Point Location

Figure 6-12. A4 AC Input Board, Schematic Diagram

Figure 6-13. A5 DC Rail Board, Component and Test Point Location

Figure 6-14. A5 DC Rail Board, Schematic Diagram

Figure 6-15. A6 Bias Board, Component and Test Point Location

Figure 6-16. A6 Bias Board, Schematic Diagram (Sheet 1 of 2)

Figure 6-16. A6 Bias Board, Schematic Diagram (Sheet 2 of 2)

Figure 6-17. Power Mesh, Schematic Diagram, Models 6680A, 6681A Only

Figure 6-18. Power Mesh, Schematic Diagram Models 6682A, 6683A, 6684A Only

Figure 6-19. A7 Snubber Board, Component Location

Figure 6-20. A7 Snubber Board, Schematic Diagram

Figure 6-21. A8 Fast Sense Board, Component Location

Figure 6-22. A8 Fast Sense Board, Schematic Diagram

Figure 6-23. A9 Down Programming/Slow Sense, Component Location

Figure 6-24. A9 Down Programming/Slow Sense, Schematic Diagram

Figure 6-25. A10 Control Board, Component and Test Point Location

Figure 6-26. A10 Control Board, Schematic Diagram (Sheet 1 of 4)

Figure 6-26. A10 Control Board, Schematic Diagram (Sheet 2 of 4)

Figure 6-26. A10 Control Board, Schematic Diagram (Sheet 3 of 4)

Figure 6-26. A10 Control Board, Schematic Diagram (Sheet 4 of 4)

Backdating

Manual backdating describes changes that must be made to this manual for power supplies whose serial numbers are lower than those listed in the title page to this manual.

Look in the following table and locate your Agilent model. Then look at each serial number listed for this group. If the serial number of your power supply is **prior** to any of the serial number(s) listed, perform the change indicated in the **Change** column. Note that, several changes can apply to your supply.

Serial Numbers	Change
Model 6680A	
3318A 00111	1, 2, 4, 5, 6
3318A 00116	3
3502A 00126	7
3619A 00167	9
Model 6681A	
3319A 00154	4
3336A 00164	1
3350A 00172	2, 6
3350A 00183	5
3350A 00193	3
3506A 00218	7
3619A 00383	9
Model 6682A	
3349A 00104	6
3349A 00108	3
3514A 00123	7
3514A 00168	8
3624A 00193	9

Serial Numbers	Change
Model 6683A	
3349A 00104	6
3349A 00108	3
3514A 00123	7
3514A 00178	8
3619A 00203	9
Model 6684A	
3339A 00103	5
3405A 00108	3
3405A 00109	6
3514A 00118	7
3514A 00188	8
3514A 00257	9

CHANGE 1

In Table 5-14 A10 Control Board

DELETE C548, 0.1uF 50V, Agilent P/N 0160-4835 in parallel with RT500.

CHANGE 2

In Table 5-7 A3 FET Board

DELETE C228 & 231, 2000pF 100V P/N 0160-2301.

ADD C228, 6800pF 100V P/N 0160-4904.

CHANGE R247, from 75K P/N 0757-0462, to 42.2K 1% 1/8W P/N 0698-3450.
 R249, from 13.1K P/N 0757-0444, to 7.5K 1% 1/8W P/N 0757-0440
 R250, from 60.4K P/N 0698-3572 to 40.2K 1% 1/8W P/N 0698-3499.
 R253, from 12.5K P/N 0698-6533 to 17.8K 1% 1/8W P/N 0698-3136.
 C229, from 0.022uF P/N 0160-4918 to 0.01uF 100V Ceramic P/N 0160-4832.

In Table 5-9 A5 DC Rail Board

- DELETE** C418, 0.022uF 250VAC "Y" rated P/N 0160-4048
Fuse Clips, REF F420 & 421 1/4" P/N 2110-0726, qty, 4.
- ADD** Fuse Holder, REF F420 & 421, 5 x 30mm P/N 2110-0689, qty 2.
- CHANGE** F420 & 421, from 0.5A 500V P/N 2110-0934 to 0.5A 500V 5x30mm P/N 2110-0921.

CHANGE 3

In Table 5-14 A10 Control Board

- DELETE** C548, 0.1uF 50V P/N 0160-4835. in parallel with RT500.
RT500, P/N 0837-0412.
Pins, P/N 0360-1498, qty. 2.

CHANGE 4

In Table 5-14 A10 Control Board

- DELETE** ASSEMBLY, relay contactor P/N 5060-3593, qty. 1.
- ADD** Dust cover for relay, P/N 9222-1870.
Retainer clip for relay, P/N 1460-2317.
Relay, P/N 0490-1919.

CHANGE 5

In Table 5-8 A4 AC Input Board

- DELETE** C428, 429, and 430, P/N 0160-7898.
R435, 436, and 437, P/N 0698-3609.

CHANGE 6

In Table 5-6 A2 GPIB Board

- CHANGE** A2 GPIB board from P/N 5060-3591 to P/N 5060-3552. (see Table A-1 and Figure A-1)

CHANGE 7

In Table 5-6 A2 GPIB Board

- CHANGE** U114 from P/N 1826-0536, to LM309K P/N 1820-0430.

CHANGE 8

In Table 5-13 A9 Downprogrammer/Slow Sense Board

- CHANGE** Q981, 982 from P/N 1855-1003, to POWER MOSFET P/N 1855-0835.
- DELETE** Insulator, REF Q981, 982.

CHANGE 9

In Table 5-10 A1 Front Panel Board

- CHANGE** KNOB (Ref. RPG) from P/N 0370-3238, to P/N 10370-1091.
RPG - OPTICAL ENCODER from P/N 0960-0912 to P/N 0960-0822.
U4 from 5080-2466 to P/N 5080-2304.
- DELETE** PCA (keypad), P/N 5063-3407.

Table A-1. A2 GPIB Parts List

Ref Desig.	Agilent Part No.	Description
ELECTRICAL PARTS		
C102-105	0160-4822	Capacitor 1000pF 5%
C106	0180-0155	Capacitor 2.2 μ F 20V
C107,108	0160-4787	Capacitor 22pF 5% 100V
C109-111,114,115,121	0160-5422	Capacitor 0.047 μ F 20%
C122	0180-3325	Capacitor 25V
C123	0160-4822	Capacitor 1000pF 5%
C124	0180-0228	Capacitor 22 μ F 15V
C125	0160-5422	Capacitor 0.047 μ F 20%
C126,127	0160-4807	Capacitor 33pF 5% 100V
C128	0160-4281	Capacitor 2200pF 20%
C129-134	0160-5422	Capacitor 0.047 μ F 20%
C135	0180-0228	Capacitor 22 μ F 15V
C136	0160-4803	Capacitor 68pF 5% 100V
C138-140	0160-5422	Capacitor 0.047 μ F 20%
D107-110	1901-0731	Diode power rectifier
D111-114	1901-1098	Diode 1N4150
D115,116	1901-1080	Diode 1N5817
D119,120	1902-0766	Diode zener 18.2V 5%
F101	2110-0699	Fuse subminiature 5AM, 125V
J101	1252-0268	Connector receptacle (GPIB)
J106	1251-4926	Connector receptacle (test header)
J107,108,114,115	1251-7330	Connector receptacle phone
L101	9100-1610	Inductor 150nH 20%
P101	1251-4245	Connector plug 2-pin (ac bias)
Q101	1853-0089	Transistor PNP 2N4917
R103	0757-0442	Resistor 10K 1% 0.125W
R104	0698-3155	Resistor 4.64K 1%
R105	0683-1065	Resistor 10M 5% 0.25 W
R106	0698-4037	Resistor 46.4 Ω 1%
R107	0698-0082	Resistor 464 Ω 1% 0.125W
R108	0757-0401	Resistor 100 Ω 1% 0.125W
R109	0698-0082	Resistor 464 Ω 1% 0.125W
R111,114	0698-3155	Resistor 4.64K 1%
R115-117	0698-4037	Resistor 46.4 1%
R118	0757-0280	Resistor 1K 1% 0.125W
R119	0698-8827	Resistor 1M 1% 0.125W
R120-122	0698-3155	Resistor 4.64K 1%
R123	0698-0082	Resistor 464 Ω 1% 0.125W
R130-133	0698-3155	Resistor 4.64K 1%
R134	0683-1015	Resistor 100 Ω 5% 0.25W
R135,136	0698-3155	Resistor 4.64K 1%
R137	0757-0401	Resistor 100 Ω 1% 0.125W

Table A-1. A2 GPIB Parts List (continued)

Ref Desig.	Agilent Part No.	Description
ELECTRICAL PARTS		
TB101	0360-2312	Terminal block (digital control)
U101	1826-0468	IC MC3423PI
U106	5080-2152	IC DROM GPIB
U108	1818-4111	IC MCM 6164C55
U109	1820-6789	IC interface
U110,111	1990-0444	IC Opto isolator
U112	1820-3210	IC 68B50
U113	1990-0543	IC Opto isolator
U114	1821-1479	IC MPU
U115	1LH4-0001	IC GP-IB transceiver
U116	1820-2724	IC SN74ALS573BN
U117	1820-2549	IC 8291A
U118	1820-4185	IC interface
U119	5080-2153	IC GAL programmed GPIB
U120	5080-2154	IC GAL programmed IPIB
U121	1820-0430	IC LM309K
VR101	1902-0766	Diode zener 18.2V 5%
VR102	1902-0959	Diode zener 11V 5%
VR103,104	1902-0049	Diode zener 6.19V 5%
W101	1258-0209	Jumper
Y101	0410-2109	Crystal oscillator 12.000MHz
MECHANICAL PARTS		
--	1205-0758	Heatsink (U121)
--	0340-1277	Insulator (Y101)
--	0535-0031	Nut hex w/lockwasher (J101)
--	0515-0642	Screw (U121)
--	0515-0911	Screw M3x0.5 (J101)
--	1200-0567	Socket IC 28-pin (U106)
--	1200-0639	Socket IC 20-pin (U119,120)
--	1200-1274	Socket IC (U114)

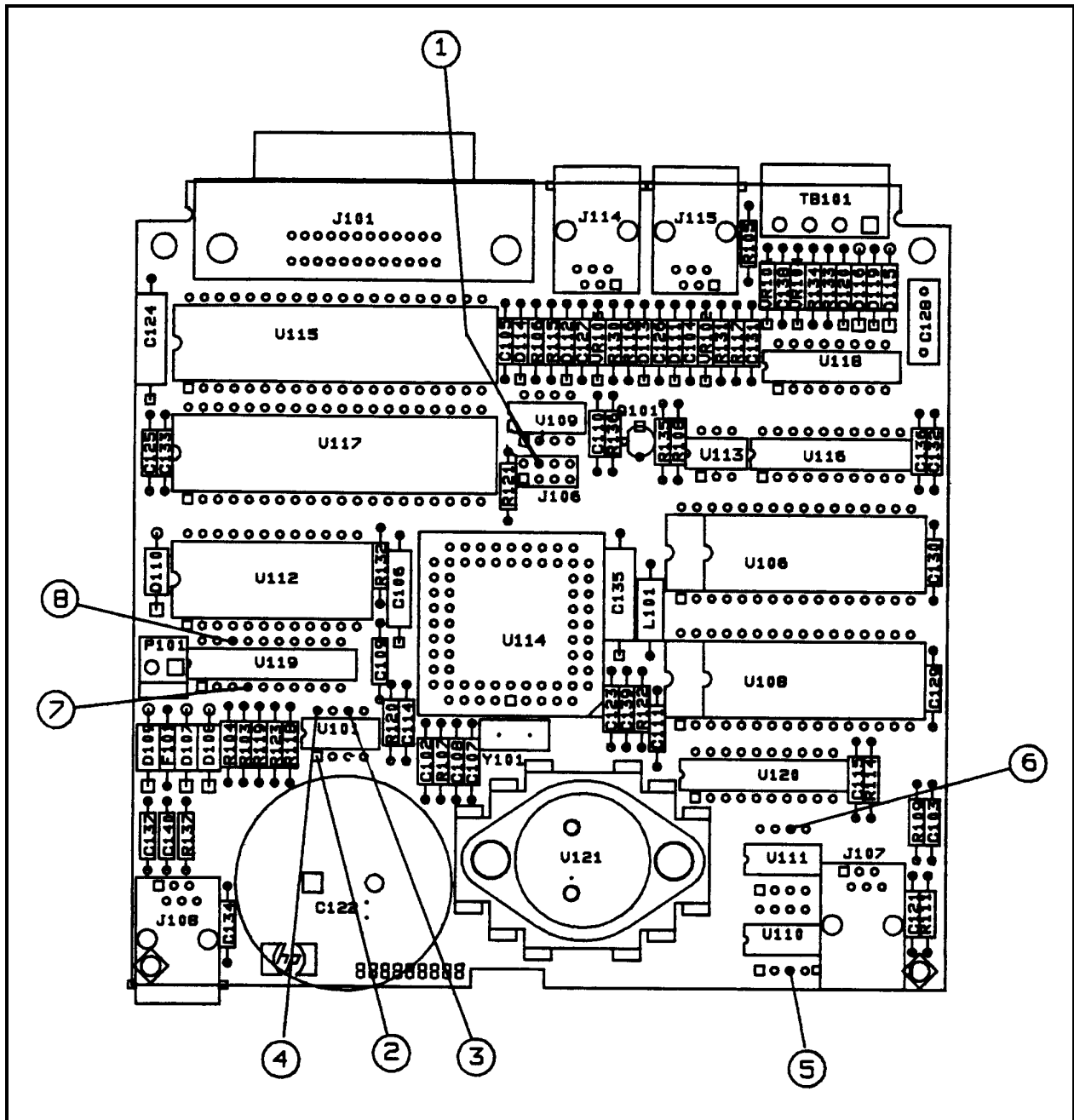

Figure A-1. A2 GPIB Component Parts List

Index

A

A1 Front Panel Board, test header	57
A2 GPIB Board, test header.....	57
A3 FET Board	
dynamic troubleshooting.....	55
static troubleshooting.....	55
test connections.....	55
test points	55, 56
analog port	8
Agilent 50504A oscilloscope.....	34
Agilent 545A logic probe.....	34

B

bias supply	36
-------------------	----

C

cable	
W3 ribbon	79
W4 phone.....	79
W5 phone.....	79
W6 ac bias	79
Cabling diagram.....	146
calibration constants, factory	66
calibration password	65
calibration, post-repair	65
calibration procedure	7
CC annunciator	55
CC load effect, testing.....	26
CC noise (PARD), testing.....	18
CC PARD, defined	18
Circuits	
isolator board	84
conductive table mat.....	9
conductive wrist strap.....	9
configuration jumper	
FACTORY PRESET CAL	59
FLT/INH.....	59
INHIBIT CAL	59
RELAY LINK	59
SA mode	59
current, maximum programmable.....	19
current, --CC	19
current programming and readback accuracy.....	19
current sink and readback accuracy, testing.....	19
CV/CC status annunciators	54
CV load effect, defined	16
CV load effect, testing	16
CV noise (PARD), defined	17
CV noise (PARD), testing.....	17

CV source effect, defined	17
CV source effect, testing.....	17
CV transient response waveform	18
CV transient recovery time, defined	18
CV transient recovery time, testing.....	18
CV voltage programming and readback accuracy, testing.....	16

D

Diagram cabling.....	146
DIG CNTL port, configuring.....	58
disassembly procedures	71
downprogrammer FETs, location of	74

E

electronic load.....	12, 20
error, checksum.....	35
error code	
E1.....	35
E10.....	35
E11.....	35
E12.....	35
E2.....	35
E3.....	35
E4.....	35
E5.....	35
E6.....	35
E7.....	35
E8.....	35
E9.....	35
error code, over GPIB	35
error code, selftest.....	35
error message	
CAL DENIED	67
DACS.....	35
EE CHKSM	35
EE WRITE ERR	35
FP RAM.....	35
FP ROM.....	35
FRAMING.....	35
GPIB	35
PASSWD ERROR.....	67
PRI IRAM.....	35
PRI ROM.....	35
PRI XRAM	35
SBuF FULL	35
SBuF OVERRUN	35
SEC 5V	35
SECONDARY DWN	35
SEC RAM.....	35
SEC ROM.....	35
SERIAL DOWN.....	35
SERIAL TIMEOUT.....	35
TEMP	35
UART OVERRUN	35

UART PARITY	35
error message, selftest	35
errors	
calibration	35
selftest	35
ESD	9, 33

F

factory calibration constants	65
firmware, revisions	8
firmware revisions	64
Form, performance test record	25
front panel EEPROM	
factory cal location	67
initialization of	67
transferring constants to	67
front panel operation	7
front panel, testing	34

G

GPIB error 2	66
GPIB interface, testing	34

I

*IDN query	58
inhibit calibration jumper	66
Isolator board circuits	87

J

jumper	
DIG I/O	59
FACTORY PRESET CAL	59
INHIBIT CAL	59
NORM	59

K

keypad	14
--------------	----

L

line fuse, replacing	9
line voltage, conversion of	9

M

manual backdating	8
manual changes sheet	8
manufacturing date, determining	8
message	
PWR ON INIT	35, 65

Mnemonics signal names	140
mutual coupling, test lead	14

N

noise, testing	14
----------------------	----

O

operating manual.....	7
oscilloscope, Agilent 54504A.....	15
output heatsink assembly	82
output rectifiers	
location of	75
replacing	75
overvoltage, maximum programmable	14

P

Performance test record form.....	25
performance tests, CC.....	19
performance tests, CV.....	16
power FETs, replacing	47
power-on selftest.....	34
power-on selftest, disabling	34
protective earth ground	9

R

record sheet, test	13
reference supply.....	34
regulation, voltage	14
removing	
A1 Front Panel Assembly	74
A1 Front Panel Board	74
A2 GPIB Board	72
A3 FET Board	73
A4 AC Input Board.....	72
A5 Control Board	73
A6 Output Filter Board.....	73
A7 Snubber Board	75
ac input filter.....	72
fan	73
heatsink assembly	73
keypad.....	75
L900 output choke	75
line switch.....	72
output subchassis	75
rear panel	72
RFI shield	72
RPG controls.....	73
T900 output transformer	72
top cover	73
Replaceable parts for A2 isolator board.....	104
resistor	
current monitoring	12

load	12
resistor, current monitor	12
resistor, current monitoring	12

S

SA	58
SA secondary interface, exiting test	58
SA signals	
A5 microprocessor	59
SA signals, secondary interface	59
SA signatures, identical	60
SA signatures, similar	60
SA test header jumper	60
Schematic notes	145
SCPI programming	8
secondary interface, testing	33
sense terminals	13
serial number	7
serial number prefix	7
settling time	13
Signal name	
mnemonics	140
Signals	
+5V bias voltage	140
BSTx	140
PCLR	140
RESET*	140
RxD	140
SPCLR*	140
SRx	140
TxD	140
XFMR TI	140
slew rate	13

T

test	
selftest	11
test equipment, troubleshooting	33
test headers	35
test leads	13
test measurements, cc mode	19
test points, troubleshooting	35
Test point waveforms	144
tests	
constant-current mode	19
constant-voltage mode	14
independent order of	14
operation verification	14
performance	14
programming	13
performance test record	25
TORX screws	71
transformer, variable-voltage	18
transient recovery time	18

Troubleshooting	
test points	142
troubleshooting chart	
output held high	36
OV at turn-on	36
secondary downprogramming	36
troubleshooting charts	36
*TST?	34
*TST? Query	34

U

UNREGULATED annunciator	55
using *IDN query	8

V

voltage, maximum programmable	13
-------------------------------------	----

Figure 6-23. A9 Down Programmer/Slow Sense, Component Location

Figure 6-24. A9 Down Programmer/Slow Sense, Schematic Diagram

Figure 6-25. A10 Control Board, Component Test Point Location

Figure 6-26. A10 Control Board, Schematic Diagram

Backdating

Manual backdating describes changes that must be made to this manual for power supplies whose serial numbers are lower than those listed in the title page to this manual.

Look in the following table and locate your HP Model. Then look at each serial number listed for this group. If the serial number of your power supply is **prior** to any of the serial number(s) listed, perform the change indicated in the **Change** column. Note that, several changes can apply to your supply.

Serial Numbers	Change
Model 6680A	
3318A 00111	1, 2, 4, 5, 6
3318A 00116	3
3502A 00126	7
3619A 00167	9
Model 6681A	
3319A 00154	4
3336A 00164	1
3350A 00172	2, 6
3350A 00183	5
3350A 00193	3
3506A 00218	7
3619A 00383	9
Model 6682A	
3349A 00104	6
3349A 00108	3
3514A 00123	7
3514A 00168	8
3624A 00193	9

Serial Numbers	Change
Model 6683A	
3349A 00104	6
3349A 00108	3
3514A 00123	7
3514A 00178	8
3619A 00203	9
Model 6684A	
3339A 00103	5
3405A 00108	3
3405A 00109	6
3514A 00118	7
3514A 00188	8
3514A 00257	9

CHANGE 1

In Table 5-14 A10 Control Board

DELETE C548, 0.1uF 50V, HP P/N 0160-4835 in parallel with RT500.

CHANGE 2

In Table 5-7 A3 FET Board

DELETE C228 & 231, 2000pF 100V P/N 0160-2301.

ADD C228, 6800pF 100V P/N 0160-4904.

CHANGE R247, from 75K P/N 0757-0462, to 42.2K 1% 1/8W P/N 0698-3450.
 R249, from 13.1K P/N 0757-0444, to 7.5K 1% 1/8W P/N 0757-0440
 R250, from 60.4K P/N 0698-3572 to 40.2K 1% 1/8W P/N 0698-3499.
 R253, from 12.5K P/N 0698-6533 to 17.8K 1% 1/8W P/N 0698-3136.
 C229, from 0.022uF P/N 0160-4918 to 0.01uF 100V Ceramic P/N 0160-4832.

In Table 5-9 A5 DC Rail Board

DELETE C418, 0.022uF 250VAC "Y" rated P/N 0160-4048
Fuse Clips, REF F420 & 421 1/4" P/N 2110-0726, qty, 4.

ADD Fuse Holder, REF F420 & 421, 5 x 30mm P/N 2110-0689, qty 2.

CHANGE F420 & 421, from 0.5A 500V P/N 2110-0934 to 0.5A 500V 5x30mm P/N 2110-0921.

CHANGE 3

In Table 5-14 A10 Control Board

DELETE C548, 0.1uF 50V P/N 0160-4835. in parallel with RT500.
RT500, P/N 0837-0412.
Pins, P/N 0360-1498, qty. 2.

CHANGE 4

In Table 5-14 A10 Control Board

DELETE ASSEMBLY, relay contactor P/N 5060-3593, qty. 1.

ADD Dust cover for relay, P/N 9222-1870.
Retainer clip for relay, P/N 1460-2317.
Relay, P/N 0490-1919.

CHANGE 5

In Table 5-8 A4 AC Input Board

DELETE C428, 429, and 430, P/N 0160-7898.
R435, 436, and 437, P/N 0698-3609.

CHANGE 6

In Table 5-6 A2 HP-IB Board

CHANGE A2 HP-IB board from P/N 5060-3591 to P/N 5060-3552.

CHANGE 7

In Table 5-6 A2 HP-IB Board

CHANGE U114 from P/N 1826-0536, to LM309K P/N 1820-0430.

CHANGE 8

In Table 5-13 A9 Downprogrammer/Slow Sense Board

CHANGE Q981, 982 from P/N 1855-1003, to POWER MOSFET P/N 1855-0835.

DELETE Insulator, REF Q981, 982.

CHANGE 9

In Table 5-10 A1 Front Panel Board

CHANGE KNOB (Ref. RPG) from P/N 0370-3238, to P/N 10370-1091.
RPG - OPTICAL ENCODER from P/N 0960-0912 to P/N 0960-0822.
U4 from 5080-2466 to P/N 5080-2304.

DELETE PCA (keypad), P/N 5063-3407.

Index

A

A1 Front Panel Board, test header	57
A2 HP-IB Board, test header	57
A3 FET Board	
dynamic troubleshooting	55
static troubleshooting	55
test connections	55
test points	55, 56
analog port	8

B

bias supply	36
-------------------	----

C

cable	
W3 ribbon	79
W4 phone	79
W5 phone	79
W6 ac bias	79
Cabling diagram	146
calibration constants, factory	66
calibration password	65
calibration, post-repair	65
calibration procedure	7
CC annunciator	55
CC load effect, testing	26
CC noise (PARD), testing	18
CC PARD, defined	18
Circuits	
isolator board	84
conductive table mat	9
conductive wrist strap	9
configuration jumper	
FACTORY PRESET CAL	59
FLT/INH	59
INHIBIT CAL	59
RELAY LINK	59
SA mode	59
current, maximum programmable	19
current, --CC	19
current programming and readback accuracy, testing	19
current sink and readback accuracy, testing	19
CV/CC status annunciators	54
CV load effect, defined	16
CV load effect, testing	16
CV noise (PARD), defined	17
CV noise (PARD), testing	17

CV source effect, defined	17
CV source effect, testing.....	17
CV transient response waveform	18
CV transient recovery time, defined	18
CV transient recovery time, testing	18
CV voltage programming and readback accuracy, testing.....	16

D

Diagram cabling.....	146
DIG CNTL port,configuring.....	58
disassembly procedures.....	71
downprogrammer FETs,location of	74

E

electronic load	12, 20
error,checksum	35
error code	
E1	35
E10	35
E11	35
E12	35
E2	35
E3	35
E4	35
E5	35
E6	35
E7	35
E8	35
E9	35
error code,over HP-IB	35
error code,selftest	35
error message	
CAL DENIED	67
DACS	35
EE CHKSM.....	35
EE WRITE ERR.....	35
FP RAM	35
FP ROM	35
FRAMING.....	35
HP-IB	35
PASSWD ERROR.....	67
PRI IRAM	35
PRI ROM.....	35
PRI XRAM.....	35
SBuF FULL.....	35
SBuF OVERRUN.....	35
SEC 5V.....	35
SECONDARY DWN	35
SEC RAM.....	35
SEC ROM.....	35
SERIAL DOWN.....	35
SERIAL TIMEOUT	35
TEMP	35

UART OVERRUN.....	35
UART PARITY.....	35
error message,selftest.....	35
errors	
calibration.....	35
selftest.....	35
ESD.....	9, 33

F

factory calibraion constants.....	65
firmware,revisions.....	8
firmware revisions.....	64
Form, performance test record.....	25
front panel EEPROM	
factory cal location.....	67
initialization of.....	67
transferring constants to.....	67
front panel operation.....	7
front panel,testing.....	34

H

HP 50504A oscilloscope.....	34
HP 545A logic probe.....	34
HP-IB error 2.....	66
HP-IB interface,testing.....	34

I

*IDN query.....	58
inhibit calibration jumper.....	66
Isolator board circuits.....	87

J

jumper	
DIG I/O.....	59
FACTORY PRESET CAL.....	59
INHIBIT CAL.....	59
NORM.....	59

K

keypad.....	14
-------------	----

L

line fuse, replacing.....	9
line voltage, conversion of.....	9

M

manual backdating.....	8
------------------------	---

manual changes sheet.....	8
manuFacturing date,determining.....	8
message	
PWR ON INIT	35, 65
Mnemonics signal names	140
mutual coupling, test lead	14

N

noise, testing	14
----------------------	----

O

operating manual	7
oscilloscope, HP 54504A	15
output heatsink assembly	82
output rectifiers	
location of.....	75
replacing	75
overvoltage, maximum programmable	14

P

Performance test record form	25
performance tests, CC.....	19
performance tests, CV	16
power FETs,replacing.....	47
power-on selftest.....	34
power-on selftest,disabling	34
protective earth ground	9

R

record sheet, test	13
reference supply.....	34
regulation, voltage	14
removng	
A1 Front Panel Assembly	74
A1 Front Panel Board	74
A2 HP-IB Board.....	72
A3 FET Board	73
A4 AC Input Board	72
A5 Control Board	73
A6 Output Filter Board.....	73
A7 Snubber Board	75
ac input filter	72
fan.....	73
heatsink assembly	73
keypad	75
L900 output choke.....	75
line switch.....	72
output subchassis	75
rear panel	72
RFI shield	72
RPG controls	73

T900 output transformer.....	72
top cover.....	73
Replaceable parts for A2 isolator board.....	104
resistor	
current monitoring.....	12
load.....	12
resistor, current monitor.....	12
resistor, current monitoring.....	12

S

SA.....	58
SA secondary interface, exiting test.....	58
SA signals	
A5 microprocessor.....	59
SA signals, secondary interface.....	59
SA signatures, identical.....	60
SA signatures, similar.....	60
SA test header jumper.....	60
Schematic notes.....	145
SCPI programming.....	8
secondary interface, testing.....	33
sense terminals.....	13
serial number.....	7
serial number prefix.....	7
settling time.....	13
Signal name	
mnemonics.....	140
Signals	
+5V bias voltage.....	140
BSTx.....	140
PCLR.....	140
RESET*.....	140
RxD.....	140
SPCLR*.....	140
SRx.....	140
TxD.....	140
XFMR T1.....	140
slew rate.....	13

T

test	
selftest.....	11
test equipment, troubleshooting.....	33
test headers.....	35
test leads.....	13
test measurements, cc mode.....	19
test points, troubleshooting.....	35
Test point waveforms.....	144
tests	
constant-current mode.....	19
constant-voltage mode.....	14
independent order of.....	14
operation verification.....	14

performance.....	14
programming.....	13
performance test record.....	25
TORX screws.....	71
transformer, variable-voltage.....	18
transient recovery time.....	18
Troubleshooting	
test points.....	142
troubleshooting chart	
output held high.....	36
OV at turn-on.....	36
secondary downprogramming.....	36
troubleshooting charts.....	36
*TST?.....	34
*TST? Query.....	34

U

UNREGULATED annunciator.....	55
using *IDN query.....	8

V

voltage, maximum programmable.....	13
------------------------------------	----